

## **GPSMAP® 496** *portable aviation receiver*



© 2006–2007 Garmin Ltd. or its subsidiaries

Garmin International, Inc.  
1200 East 151st Street,  
Olathe, Kansas 66062, USA  
Tel. (913) 397.8200 or (800) 800.1020  
Fax (913) 397.8282

Garmin (Europe) Ltd.  
Liberty House  
Hounslow Business Park,  
Southampton, Hampshire, SO40 9RB UK  
Tel. +44 (0) 870.8501241 (outside the UK)  
0808 2380000 (within the UK)  
Fax +44 (0) 870.8501251

Garmin Corporation  
No. 68, Jangshu 2nd Road,  
Shijr, Taipei County, Taiwan  
Tel. 886/2.2642.9199  
Fax 886/2.2642.9099

All rights reserved. Except as expressly provided herein, no part of this manual may be reproduced, copied, transmitted, disseminated, downloaded or stored in any storage medium, for any purpose without the express prior written consent of Garmin. Garmin hereby grants permission to download a single copy of this manual onto a hard drive or other electronic storage medium to be viewed and to print one copy of this manual or of any revision hereto, provided that such electronic or printed copy of this manual must contain the complete text of this copyright notice and provided further that any unauthorized commercial distribution of this manual or any revision hereto is strictly prohibited.

Information in this document is subject to change without notice. Garmin reserves the right to change or improve its products and to make changes in the content without obligation to notify any person or organization of such changes or improvements. Visit the Garmin Web site ([www.garmin.com](http://www.garmin.com)) for current updates and supplemental information concerning the use and operation of this and other Garmin products.

Garmin®, GPSMAP®, AutoLocate®, TracBack®, BlueChart®, MapSource®, and See-Thru® are trademarks of Garmin Ltd. or its subsidiaries, registered in the USA and other countries. These trademarks may not be used without the express permission of Garmin.

XM WX Weather and XM Radio are trademarks of XM Satellite Radio Inc.

# Introduction

Thank you for choosing the Garmin GPSMAP® 496, an unsurpassed portable aviation receiver that utilizes the proven performance of Garmin GPS, full-featured built in City Navigator mapping, AOPA Airport Directory, SafeTaxi Airport Diagrams, XM Radio, and XM WX Weather. Take a moment now to compare the contents of this package with the packing list on the outside of the box. If any pieces are missing, contact your Garmin dealer immediately.

## About This Manual

To get the most out of your new navigation system, read this manual and learn the operating procedures for your unit.

## Manual Conventions

This manual uses the term **Warning** to indicate a potentially hazardous situation, which, if not avoided, could result in death or serious injury.

This manual uses the term **Caution** to indicate a potentially hazardous situation, which, if not avoided, may result in minor injury or property damage. It may also be used without the symbol to alert you to avoid unsafe practices.

## Table of Contents

<b>Introduction</b> .....	<b>i</b>
About This Manual.....	i
Warnings .....	v
Battery Warnings.....	vi
Important Information .....	vi
<b>Getting Started</b> .....	<b>1</b>
Unit Overview .....	1
Charging the GPSMAP 496.....	2
Turning On the GPSMAP 496 .....	3
Getting Satellite Signals .....	4
Learning About the Keypad .....	7
Using the GPSMAP 496 .....	8
Simulator Mode .....	11
<b>Basic Operation In Aviation Mode</b> .....	<b>13</b>
Aviation Mode Page Sequence .....	13
Creating a Direct To.....	14
Finding a Nearby Point.....	18
Selecting an Approach .....	23
Finding Points on Land.....	25
Marking a Waypoint.....	26
Creating a Flight Plan (Route).....	27
Following your Flight Plan .....	28

<b>Aviation Mode Pages</b> .....	<b>29</b>
Map Page.....	29
Terrain Page.....	37
Panel Page.....	40
Active Route Page.....	44
Position Data Page.....	45
Flight Log.....	46
Aircraft Information .....	47
E6B Tab.....	49
XM Audio Page.....	51
<b>Basic Operation In Automotive Mode</b> .....	<b>55</b>
Automotive Mode Page Sequence.....	55
Navigating in Automotive Mode.....	56
Finding an Item.....	58
Creating Routes .....	61
Creating Waypoints .....	63
Following an Automotive Route.....	66
Editing Your Route.....	67
<b>Automotive Mode Pages and Features</b> .....	<b>69</b>
Map Page.....	69
Highway Page .....	70
Current Route Page .....	72
Trip Computer.....	73
Editing and Managing Routes .....	74
Editing and Managing Waypoints.....	78
Managing Your Tracks.....	87

<b>Basic Operation in Marine Mode.....</b>	<b>91</b>	<b>Using XM WX Weather .....</b>	<b>126</b>
Marine Mode Page Sequence.....	91	Viewing XM WX Weather .....	126
Navigating in Marine Mode.....	92	Setting XM WX Weather Options .....	127
<b>Marine Mode Pages and Features.....</b>	<b>93</b>	Using the Weather Tab .....	130
Map Page.....	93	Finding Weather Information .....	133
Compass Page.....	94	<b>Setting up and Using Sonar .....</b>	<b>135</b>
DSC.....	96	Showing Sonar on the Map Page.....	135
<b>Main Menu.....</b>	<b>101</b>	Using the Sonar Page .....	136
GPS Tab .....	101	Setting Up the Sonar Page.....	140
Weather Tab .....	102	Understanding Sonar .....	143
XM Tab .....	102	Viewing the Sonar Temperature Tab .....	146
Flights Tab .....	103	<b>TIS(Traffic Information Service) .....</b>	<b>147</b>
Route Tab .....	103	TIS Limitations.....	148
Points Tab.....	104	TIS Symbology .....	150
Track Tab.....	104	Traffic Ground Track .....	151
Sonar Tab .....	105	Traffic Warning Window.....	151
Aircraft Tab .....	105	Map Page .....	152
Alarms Tab.....	106	TIS Operational Procedures.....	153
Celestial Tab.....	109	<b>VHF Comm .....</b>	<b>154</b>
Message Tab .....	113		
Display Tab.....	114		
Sound Tab .....	115		
Setup Tab .....	116		
Location Sub Tab.....	120		

<b>Appendix .....</b>	<b>155</b>
Specifications .....	155
Care Information .....	156
Optional Accessories .....	157
Installation Information .....	158
Learning About GPS.....	163
LORAN TD Setup.....	165
Map Datums and Location Formats .....	167
Digital Selective Calling (DSC).....	168
Jeppesen Database Information .....	170
Messages .....	171
Data Field Options.....	174
License Agreement and Warranty .....	177
<b>Index .....</b>	<b>181</b>

## Warnings

### **Failure to avoid the following potentially hazardous situations could result in an accident or collision resulting in death or serious injury.**

- When installing the unit in a vehicle, place the unit securely so it does not obstruct the driver's view of the road or interfere with vehicle operating controls, such as the steering wheel, foot pedals, or transmission levers. Do not place in front of or above any airbag. (See diagram.)



*Do not mount in front of an airbag field of deployment.*

- When navigating, carefully compare information displayed on the unit to all available navigation sources, including information from street signs, visual sightings, and maps. For safety, always resolve any discrepancies or questions before continuing navigation and defer to posted road signs.
- Always operate the vehicle in a safe manner. **Do not become distracted by the unit while driving, and always be fully aware of all driving conditions.** Minimize the amount of time spent viewing the unit's screen while driving and use voice prompts when possible. Do not input destinations, change settings, or access any functions requiring prolonged use of the unit's controls while driving. Pull over in a safe and legal manner before attempting such operations.

- The unit is designed to provide route suggestions. It is not designed to replace the need for driver attentiveness regarding road closures or road conditions, traffic congestion, weather conditions, or other factors that may affect safety while driving.
- Use the electronic chart in the unit only to facilitate, not to replace, the use of authorized government charts. Official government charts and notices to mariners and pilots (NOTAMs) contain all information needed to navigate safely.
- When navigating in an aircraft, use the GPSMAP 396 only as an aid for VFR navigation. Use terrain and obstacle data only as an aid to situational awareness.
- Use this unit only as a navigational aid. Do not attempt to use the unit for any purpose requiring precise measurement of direction, distance, location, or topography. This product should not be used to determine ground proximity for aircraft navigation.
- This TFR Overlay Display System (TDOS) is updated Monday -Friday, 1200-2000 UTC. **CONFIRM DATA ACCURACY THROUGH ALTERNATE SOURCES AT OTHER TIMES.** For interpretation of this TFR contact your local FSS.

## Battery Warnings

If these guidelines are not followed, the internal lithium-ion battery may experience a shortened life span or may present a risk of damage to the GPS unit, fire, chemical burn, electrolyte leak, and/or injury.

- Contact your local waste disposal department to properly dispose of the unit/battery.
- Do not leave the unit exposed to a heat source or in a high temperature location, such as in the sun in an unattended vehicle on a hot day. To prevent damage, remove the unit from the vehicle or store it out of direct sunlight, such as in the glove box.
- Do not puncture or incinerate.
- When storing the unit for a limited length of time, store within the following temperature range: -4° to 140°F (-20° to 60°C). When storing the unit for an extended time, store within the following temperature range: 32° to 77°F (0° to 25°C).
- Do not operate the unit outside of the following temperature range: -4° to 131°F (-20° to 55°C).
- Do not recharge the battery out of the unit or disassemble the battery.
- Keep the used battery away from children. Do not disassemble, puncture, or damage the battery.
- Only replace with a Garmin lithium-ion battery pack. Using another battery presents a risk of fire or explosion. To purchase a replacement battery, see your Garmin dealer or the Garmin Web site.

**WARNING:** This product, its packaging, and its components contain chemicals known to the State of California to cause cancer, birth defects, or reproductive harm. This notice is provided in accordance with California's Proposition 65. See [www.garmin.com/prop65](http://www.garmin.com/prop65) for more information.

## Important Information

**MAP DATA INFORMATION:** One of the goals of Garmin is to provide customers with the most complete and accurate cartography that is available to us at a reasonable cost. We use a combination of governmental and private data sources, which we identify in product literature and copyright messages displayed to the consumer. Virtually all data sources contain some inaccurate or incomplete data. In some countries, complete and accurate map information is either not available or is prohibitively expensive.

**TFR Data:** Temporary Flight Restriction (TFR) data is provided by the FAA and may not be updated outside of normal business hours. Confirm data currency through alternate sources and contact your local FSS for interpretation of TFR data.

The **California Electronic Waste Recycling Act of 2003** requires the recycling of certain electronics. For more information on the applicability to this product, see [www.erecycle.org](http://www.erecycle.org).



# Getting Started

## Unit Overview

The GPSMAP 496 is an all-in-one, versatile color aviation, automotive, and marine navigator—perfect for air, land, or water. This portable GPS navigator features a 256-color TFT screen that is easy to read in bright sun, a built-in City Navigator basemap, AOPA Airport Directory, SafeTaxi Airport Diagrams, Jeppesen aviation database, and auto routing to provide you with automatically generated turn-by-turn directions. With the included GXM 30A antenna and a subscription to XM WX Satellite Weather, pilots have constant access to NEXRAD radar, lightning, METARs, TAFs, TFRs, and more. In addition, the GPSMAP 496 offers XM Satellite Radio capabilities, featuring more than 150 digital channels of commercial free music; more than 30 channels of news, sports, talk and entertainment; and more than 20 dedicated channels of XM Instant Traffic & Weather.

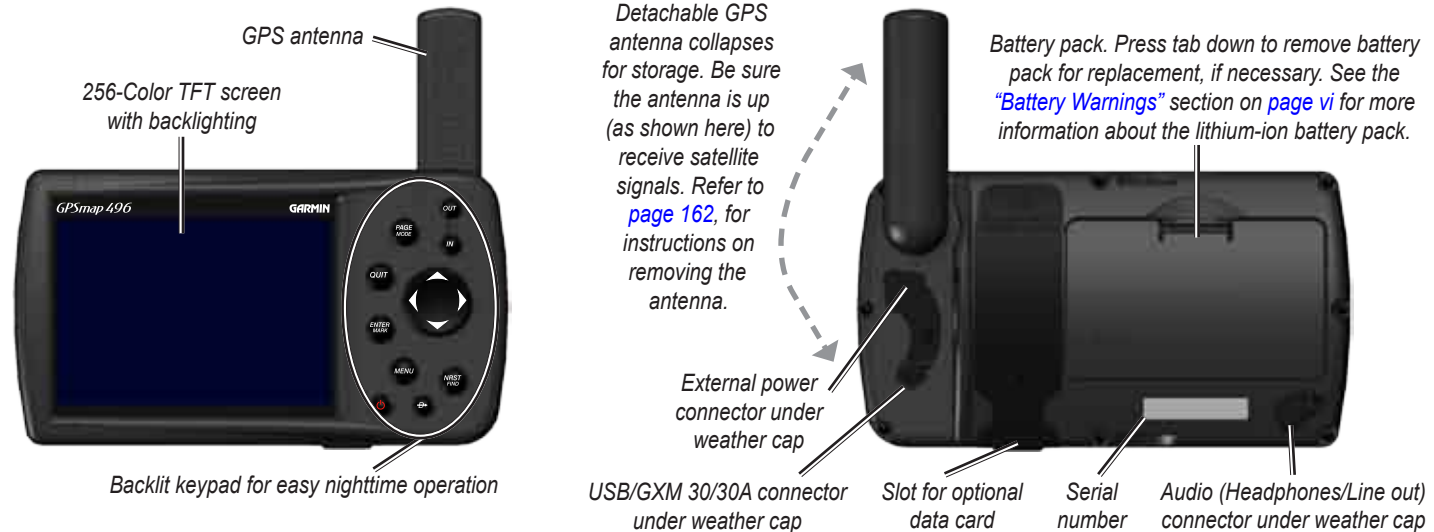

## Charging the GPSMAP 496

Before using the unit, you need to charge the battery in the GPSMAP 496. Plug the unit into a 12-Volt connector to charge. You can use the unit while it is charging.

### To charge the unit's battery:

1. Lift the rubber weather cap to expose the power connector on the back of the unit. Refer to the image on [page 1](#) for connector location.
2. Align the notches, and push the plug into the connector until fully seated.
3. Plug the vehicle power cable into a vehicle power outlet (cigarette lighter receptacle) if you have a vehicle power cable. Use care when routing the power cable; be certain that it does not interfere with vehicle operation.

The unit begins charging as soon as external power is applied. Placing the unit in Charge Mode charges the unit more quickly than when the unit is turned on and reduces draw on the aircraft/vehicle/boat battery.

### Information about Charge Mode

Applying external power to the GPSMAP 496 automatically turns on the unit for full operation. If the battery is present and needs to be charged, the external power source charges the battery while the unit is in use.

If you do not want to use the unit, but you would like to charge the battery, you can put the unit into Charge Mode. Connect the unit to an external power supply. Press and hold the **POWER** key. Instead of completely turning off, the unit now goes into Charge Mode, as shown below.

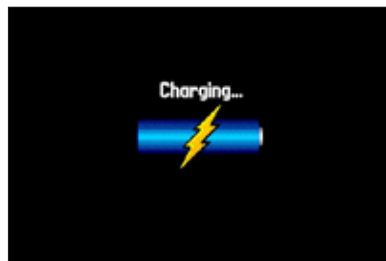

**Charge Mode**



**NOTE:** While in Charge Mode, the unit draws a small amount of current from the aircraft/vehicle/boat battery. To avoid discharging the vehicle's battery, disconnect the external power cable from the GPSMAP 496 when not in use for several days.

After using the unit a lot, you may notice that the lithium-ion battery in the unit is not holding a charge any more. This is common for lithium-ion batteries. Contact Garmin or your Garmin dealer to order a battery pack replacement if you are experiencing charging issues with your battery.

## Turning On the GPSMAP 496

The first time you turn on your new GPSMAP 496, the receiver must collect satellite data and establish its present location. To ensure proper initialization, the GPSMAP 496 is shipped from the factory in AutoLocate mode, which allows the receiver to “find itself” anywhere in the world. Before you turn on the unit to start initialization, be sure that the antenna is rotated up as shown on [page 1](#), and it has a clear and unobstructed view of the sky to receive satellite signals.

### To turn the GPSMAP 496 on and off:

1. Press and hold the **POWER** key. When the unit turns on, a tone sounds and the Warning Page appears.



Warning Page

2. Read and be sure you understand the warning. Press **ENTER** to continue.

3. To turn off the GPSMAP 496, press and hold the **POWER** key again.

## Adjusting the Backlight and Volume

The **POWER** key controls the 10 level backlight and volume of the optional headphone jack or external speaker with vehicle power cable.

### To adjust the backlight level or volume:

1. Press and quickly release the **POWER** key.
2. Press the **ROCKER** up to increase the brightness or down to decrease. Press right to raise the volume or left to lower.
3. Press **ENTER** or **QUIT** to close the Backlight/Volume adjustment window. Press **MENU** to view the options menu.

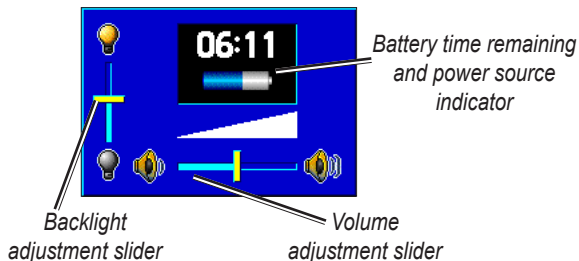

## Getting Satellite Signals

After you turn on the GPSMAP 496, the unit automatically begins searching for satellites. The GPS Page appears while the unit is gathering satellite signals and acquiring a fix. This process should take only a few minutes. While the GPSMAP 496 is getting satellite signals, the GPS Page shows the status as “Acquiring Satellites.”

It can take a few minutes to acquire satellites and show your current location on the map. Be patient as the unit acquires satellite data. To get signals more quickly, be sure the antenna is raised to the up position shown in the image on [page 1](#).

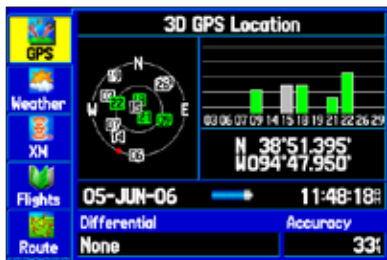

GPS Page



**NOTE:** While acquiring satellites, the Map Page can show the wrong location, such as China. This does not mean your unit has the wrong data loaded. The GPS receiver needs a few more minutes to acquire satellites and find your current location.

## Viewing GPS Status With the GPS Tab

The GPS tab provides a visual reference of satellite acquisition, receiver status, and accuracy. The sky view and signal strength bars give an indication of what satellites are visible to the receiver and whether they are being tracked.

As the receiver locks onto satellites, a signal strength bar appears for each satellite in view, with the appropriate satellite number underneath each bar. The numbers shown below each bar represent the particular satellite that is being received. Numbers above 33 indicate WAAS satellites.

The sky view shows a birds-eye view of the location of each satellite relative to the receiver’s last known location. The outer circle represents the horizon (north up), the inner circle represents 45° above the horizon, and the center point represents a location directly overhead. You can also set the sky view to a Track Up configuration, causing the top of the sky view to align along your current track heading.

A power source indicator shows the unit is operating off battery (🔋), that the unit is charging (🔌🔋), or that an external power source is in use (🔌🔋).

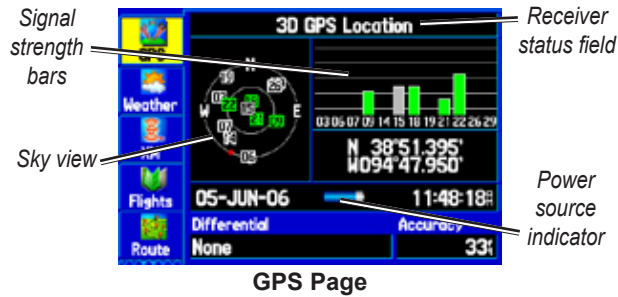

GPS Page

The progress of satellite acquisition is shown in three stages:

- **No signal strength bars**—the receiver is looking for the satellites indicated.
- **White signal strength bars**—the receiver has found the satellite and is collecting data.
- **Green signal strength bars**—the receiver has collected the necessary data from this satellite.

As soon as the GPSMAP 496 has collected the necessary data from the best satellites in view to calculate a fix, the status field indicates the status of the receiver. The unit then updates the location, date, and time.

## Receiver Status

The Receiver Status field shows one of the following conditions:

- **Searching the Sky**—the receiver is looking for satellites.
- **AutoLocate**—the receiver is looking for any satellite whose almanac has been collected, which can take up to 5 minutes.
- **Acquiring Satellites**—the receiver is looking for and collecting data from satellites visible at its last known or initialized location, but has not acquired a fix.
- **2D GPS Location**—At least three satellites have been acquired and a two-dimensional location fix has been calculated. “2D Differential” appears when you are receiving DGPS corrections in 2D mode and a “D” appears on the strength bar of satellites being corrected.
- **3D GPS Location**—At least four satellites have been acquired and a three-dimensional fix has been calculated. “3D Differential” appears when you are receiving DGPS corrections in 3D mode and a “D” appears on the strength bar of satellites being corrected.
- **Lost Satellite Reception**—the receiver is no longer tracking enough satellites for a 2D or 3D fix.
- **Receiver Not Usable**—the receiver is unusable, possibly due to interference or abnormal satellite conditions. Turn the unit off and back on to reset.
- **Simulating GPS**—the receiver is in Simulator Mode.
- **GPS Off**—the GPS receiver is turned off.

## GPS Tab Options

Press **MENU** two times to open the Main Menu. Use the **ROCKER** to highlight GPS. Press **MENU** to open the options menu:



**GPS Tab Options Menu**

**Start/Stop Simulator**—starts and stops Simulator Mode, which is helpful when learning how to use your unit.

**Enable WAAS**—enables WAAS capability. Refer to [page 164](#) for more information about WAAS.

**Track/North Up Skyview**—orients the sky view page on the GPS tab to north up or track up.

**New Altitude**—allows you to manually enter your altitude.

**New Location**—allows you to enter a new location automatically or using the map. When in Aviation Mode, you can enter the airport identifier.

## GPS Tips

While the receiver is gathering information, your location on the map can show as different from where you actually are located. Be patient; as soon as the receiver gathers enough satellite information, your proper location is shown on the map.

Any time you have traveled more than 600 miles with the GPS receiver turned off, the receiver can take longer than normal to initialize and find your location.

The GPS receiver can lose satellite signals due to interference from such items as buildings, tunnels, and heavy tree cover. Monitoring the GPS status is recommended.

To learn about GPS, see [page 163](#).

## Learning About the Keypad

### PAGE/MODE Key

- Press to cycle through the main pages in sequence and return the screen from a submenu page.
- Press and hold to switch between Aviation, Marine, and Automotive Modes.

### QUIT Key

- Press to cycle through the main pages in reverse sequence, revert to the previous value in a data entry field, or cancel a function.

### ENTER/MARK Key

- Press to select a highlighted option, initiate entry, and then confirm.
- Press and hold to mark a waypoint.

### MENU/WX Key

- Press to view the Options Menu for the current page.
- Press twice to show the Main Menu.
- Press and hold to toggle XM WX weather on or off on the Map Page.

### POWER Key

- Press and hold to turn the unit on or off.
- Press and release to adjust the backlighting and external speaker volume.



### IN/OUT Keys

- Press to zoom in or out on the Map Page.

### ROCKER Keypad

- Press up, down, right or left to move through lists, highlight fields, on-screen buttons and icons, enter data, or move the map pointer.

### NRST/FIND Key

- Shows the nearest airports, nav aids, points of communication, and airspace boundaries in Aviation Mode.
- Press multiple times in Aviation Mode to show the Find Menu.

### DIRECT TO Key

- Press to start a Go To using airports, nav aids, recently used waypoints, or user-created waypoints.
- Press and hold to show additional information for the current destination (such as communication frequency and runway data).
- While in Automotive Mode, press and hold for more than one second to show the Next Turn Page and announce the next turn.

## Using the GPSMAP 496

This section explains how to enter and select information with the GPSMAP 496. To switch between Aviation, Marine, and Automotive Modes, press and hold **PAGE**. Use the **ROCKER** to select a mode, and press **ENTER**.

### Understanding Terms

The GPSMAP 496 unit's advanced keypad system is designed to allow quick, convenient selection of navigation options and data entry. As you progress through this owner's manual, you are directed to press a specific key or highlight a field on the screen. When you are directed to press a key, you should press and quickly release the key. If the key needs to be held down for a period of time to start a secondary function, the instructions tell you to do so. When a field is selected on the screen, it is highlighted in yellow. The location of the highlight is controlled by the **ROCKER**.

The following features are referred to throughout this manual:

**Highlight**—move the highlighted area on the screen up, down, left, or right with the **ROCKER** to select individual fields. Moving the highlight to a given location allows you to make a selection, begin data entry, or scroll through a list.

**Field**—the location on a page where data or an option can be entered and shown. Select (highlight) a field using the **ROCKER** to begin entering data or selecting options.

**On-Screen Button**—use the **ROCKER** to highlight a button and press **ENTER** to select the button.

**Scroll Bar**—when viewing a list of items too long to show on the screen, a scroll bar appears along the right side of the list. The location of the scroll bar indicates which portion of the list is currently shown. To scroll through a list, press up or down on the **ROCKER**.

**Default**—the factory setting saved in the unit's memory. You can change the settings as you like, but you can also revert to the factory (default) settings when you select Restore Defaults.

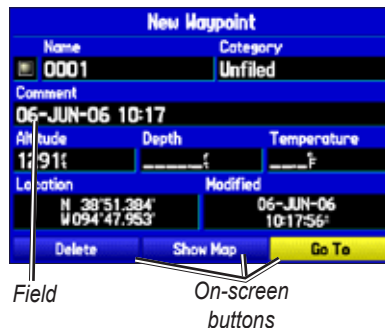



## Selecting Options and Entering Data

To enter data and select options, you must use the **ROCKER** to highlight, select, or choose an item in a list or a field on the screen. Use the **ENTER** and **ROCKER** keys to select options, enter names and numbers in data fields, and start your selections.

### To select and start an option:

1. Press **MENU** on any page. An options menu appears with a list of optional features for that page.
2. Use the **ROCKER** to move the highlight up, down, right, or left on the menu to your selection.

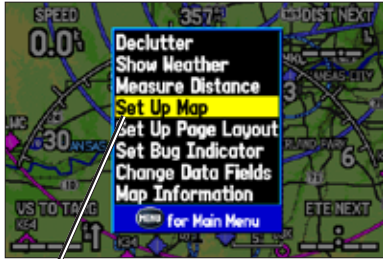

Selecting an option from an options menu.

### To exit a menu or return to the previous setting:

1. Press **QUIT** to move backward through your steps.
2. To return to the starting page, press **QUIT** repeatedly.

### To select and start an on-screen button:

1. On a page with on-screen buttons, use the **ROCKER** to highlight the on-screen button you want.
2. Press **ENTER**.



On-Screen Button

**To enter data in a data field:**

1. Use the **ROCKER** to highlight the data field you want, and press **ENTER** to activate the field.
2. Press up or down on the **ROCKER** to select characters. Press right to move to the next character or press left to move back to the previous character. If there are two lines of data, keep pressing right to drop to the next line.
3. After entering the data, press **ENTER**.

**Entering Data**

**NOTE:** To clear the entire data field, highlight the left-most character field and press left once more on the **ROCKER**.

Not all fields are programmable. When you are on a page with fields that are not selectable, the highlight skips over them.

**GPSMAP 496 Databases**

Your GPSMAP 496 comes with built-in City Navigator street and points of interest mapping, AOPA Airport Directory, Jeppesen® database, Obstacle database, Terrain database, and Voice Guidance database. You also should update your Jeppesen database to use the most current data. Refer to [page 170](#) for more information.

**MapSource Detailed Maps**

Optional Garmin data cards and MapSource CD-ROMs enhance the versatility of your GPSMAP 496. With optional BlueChart g2 data, you can access marine nav aids, wrecks, obstructions, and anchorage locations.

The included USB Interface Cable or an optional PC Interface Cable (with a serial connector) is used to transfer MapSource CD-ROM data to the optional data card.

For compatible MapSource products, refer to the Garmin Web site at [www.garmin.com/cartography](http://www.garmin.com/cartography).

## Simulator Mode

The GPSMAP 496 contains a Simulator Mode. Simulator Mode is helpful for practicing with the unit indoors or when no satellite or XM signals are available or if either antenna is not connected. All waypoints and routes created in Simulator Mode are retained in memory for future use. The following section describes how to use Simulator Mode and walks you through some basic navigation using the simulator.



**NOTE:** Do not attempt to navigate using Simulator Mode. When the unit is set to Simulator Mode, the GPS receiver is turned off. Any Satellite Signal Strength Bars shown are only simulations and do not represent the strength of actual satellite signals.

## Starting Simulator Mode

You can start Simulator Mode from the GPS tab or the Setup tab on the Main Menu.

### To start Simulator Mode using the GPS tab:

1. Press **MENU** twice to show the Main Menu.
2. Highlight **GPS** from the vertical menu.
3. Press **MENU** to open the GPS tab options menu.
4. Highlight **Start Simulator**, and press **ENTER**.



### To start Simulator Mode using the Setup tab:

1. Press **MENU** twice to show the Main Menu.
2. Highlight **Setup** from the vertical menu.
3. Highlight the **System** sub tab.
4. Select **Simulator** from the System Mode field.

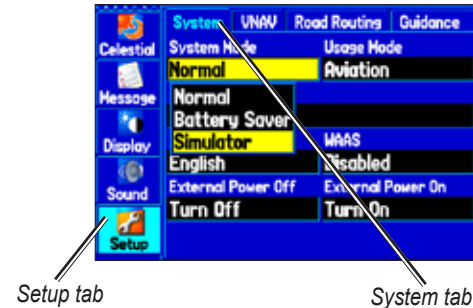

## Entering a New Location

From the GPS options menu you can enter a New Location and New Altitude to simulate from.

### To enter a New Location using the map:

1. Press **MENU** twice, and highlight **GPS** from the vertical menu.
2. Press **MENU** to open the options menu.
3. Highlight **New Location**, and press **ENTER**.
4. Highlight **Use Map**, and press **ENTER**.
5. Use the **ROCKER** to move the panning arrow to the location on the map you want, and press **ENTER**.

You can also select a New Location by entering an airport identifier (code). Select **Use Identifier** from the GPS tab options menu. Enter the airport code using the **ROCKER**. Refer to [page 14](#) for complete instructions about entering airport identifiers and user waypoints.

### To adjust the simulated speed, heading, and altitude from the Panel, Pointer, or Highway Pages:

1. Press up on the **ROCKER** increase the speed in 10 knot/kph/mph increments. Press down on the **ROCKER** to decrease the speed in the same increments.
2. Press left or right on the **ROCKER** to change heading.
3. Press the **IN** and **OUT** Zoom keys to increase or decrease altitude (Aviation Mode only).

# Basic Operation In Aviation Mode

## Aviation Mode Page Sequence

The GPSMAP 496 offers three usage modes, Aviation Mode (default), Automotive Mode, and Marine Mode. The main pages are linked together in a series that you can cycle through by pressing **PAGE** to move forward and **QUIT** to reverse. Each page also has an options menu that allows you to customize each page (in all three modes) to your preferences and/or select features that specifically relate to that page. To view the options menu for any page, press **MENU**.

Aviation Mode features five main pages: Map Page, Terrain Page, Panel Page, Active Route Page, Position Data Page, and an optional XM Audio Page. The XM Audio Page must be turned on using the Main Menu (page 114). An example of each page in Aviation Mode appears below. Each page has a specific use and is discussed later in this manual. Aviation Mode is the default mode for the GPSMAP 496. This manual first addresses each page, such as the Map Page, as shown in Aviation Mode. The manual then describes the page as shown in Automotive and Marine Mode.

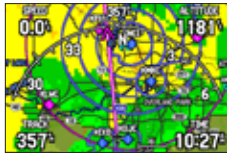

Map Page



Terrain Page



Panel Page



Active Route Page



Position Data Page

XM Audio  
(Optional)

### To switch usage modes:

1. Press and hold **PAGE/MODE**.
2. Use the **ROCKER** to select either Aviation, Automotive, or Marine, and press **ENTER**.

## Creating a Direct To

In Aviation Mode, press **Direct To**  $\Rightarrow$  to select a destination. When a Go To or route is currently in use, holding **Direct To**  $\Rightarrow$  down briefly shows a detailed information page for the current destination.

In Marine or Automotive Mode, pressing **Direct To**  $\Rightarrow$  shows the Navigate menu, which allows you to start navigation or edit a route. Also, in Marine Mode, pressing **Direct To**  $\Rightarrow$  twice creates a MOB waypoint and starts navigating to that point.

Press **MENU** on any tab of the Go To Page to open an options menu for that tab. Based on the tab you selected, you can **Show Details**, **Select Approach**, **Select Route**, **Find Land Points**, and **Remove Point**.



Go To Page: Aviation Tab

### To go to an airport or navaid:

1. Press **Direct To**  $\Rightarrow$  to show the Go To Page. Use the **ROCKER** to show the **Aviation** tab.
2. Press up or down on the **ROCKER** to select the identifier, facility name, or city field, and press **ENTER**.
3. Use the **ROCKER** to enter the word to search for. Press up and down to change the highlighted character. Press right to move to the next character field. As you scroll through the characters the GPSMAP 496 shows database entries with the same characters you have entered to that point. If more than one entry exists in the database for the characters you have entered, a window appears. Use **ENTER** and the **ROCKER** to select the point.
4. Press **ENTER** when the point is shown.
5. With the on-screen **Go To** button highlighted, press **ENTER**. The GPSMAP 496 creates a course from your present location to the selected destination.

**To go to a recently-used or user-created waypoint:**

1. Press **Direct To**  $\blacktriangleright$  to show the Go To Page. Use the **ROCKER** to select the **Recent** or **User** tab.

**Go To Page: Recent Tab**

2. Use the **ROCKER** to highlight the point from the list, and press **ENTER**.  
From the **User** tab, you can also select the top waypoint name line and then spell out the waypoint name using the **ENTER** and the **ROCKER** keys.
3. Highlight the on-screen **Go To** button, and press **ENTER**. A course is plotted from your present location to the selected destination.

**Viewing Details for the Destination**

The **Show Details** option shows detailed information for your destination waypoint or the next waypoint in a route. This feature is handy for retrieving airport information, such as communication frequencies and runway information. You can view details by using the options menu or by selecting the **Show Details** button on the Go To Page, and pressing **ENTER**.

**To view the details for the selected destination:**

1. Press **MENU** to open the options menu. Use the **ROCKER** to highlight **Show Details**, and press **ENTER**.  
OR  
Press and hold **Direct To**  $\blacktriangleright$ .  
OR  
Use the **ROCKER** to highlight **Show Details**, and press **ENTER**. A new screen appears showing sub tabs along the top of the screen.
2. Use the **ROCKER** to select the tab to view the information.

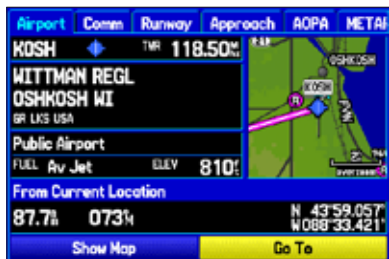

Airport Tab of Details Page

3. Highlight **Show Map**, and press **ENTER** to view the item on the map. Press **QUIT** when done. Highlight **OK**, and press **ENTER** to return to the Go To Page.

When viewing information for the Runway or Approach tabs, use the **ROCKER** to highlight the runway designation or approach name, and press **ENTER**. Then press up or down on the **ROCKER** to scroll through available runways and approaches. Press **ENTER** to select the runway or approach for which you would like to view additional information.

## Viewing Frequency Restrictions

The Comm tab on the Airport Details Page provides a list of communication frequencies for that airport. Some frequencies are noted with an asterisk (\*), which indicates that the frequency has usage restrictions. You can show the usage restriction information on your GPSMAP 496.

### To view usage restrictions for a communication frequency:

1. With the **Comm** tab selected, use the **ROCKER** to highlight any frequency with usage restrictions (noted with an asterisk), and press **ENTER**. A Usage Restrictions Page appears describing the restrictions for the selected frequency.

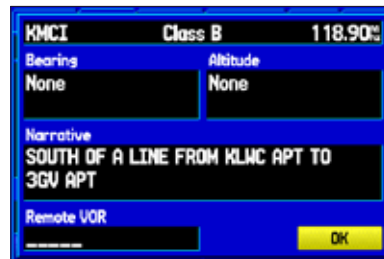

Usage Restrictions Page

2. To return to the Comm Information Page, press **ENTER**.



## Viewing AOPA Airport Directory Information

The AOPA Airport Directory contains airport statistics such as pattern altitudes, noise abatement information, FBO phone numbers, hours of operation, local attractions, ground transportation, lodging, and services.

### To view the AOPA Airport Directory information:

1. Select an airport using the map or the **NRST/FIND** key.
2. Use the **ROCKER** to select the **AOPA** tab.
3. Press up and down on the **ROCKER** to scroll through the AOPA Directory listings.

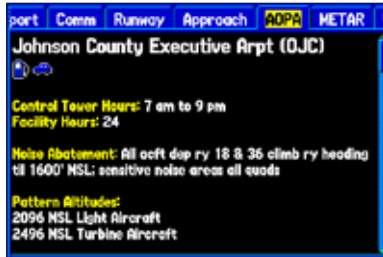

AOPA Airport Directory Tab



AOPA Service Icon Legend

## Viewing SafeTaxi™ Diagrams

Garmin SafeTaxi diagrams provide detailed taxiway diagrams and position information on more than 650 airports in the USA. Taxi diagrams are integrated in the Map Page.

### To view a SafeTaxi diagram:

1. Zoom in on an airport that has a taxi diagram available.
2. Use the **ROCKER** to view items on the taxi diagram.



SafeTaxi Airport Diagram

## Finding a Nearby Point

In Aviation Mode, press **NRST/FIND** to open the Nearest Pages. These pages provide detailed information on the nearest airports, airport weather sources, nav aids, cities, and user waypoints.

In Marine and Automotive Modes, press **NRST/FIND** to open the Find Menu. You can easily search waypoints, cities, exits, and tide stations using the Find Menu.

Airport	Wx	VOR	NDB	INT	User	City	ARTCC
Airport	Bearing	Distance	Runway	Frequency			
HBW	047°	9.3%	3000'				
4D1	057°	13.1%	2700'			122.90%	
60C	047°	13.6%	3000'			122.90%	
93C	154°	17.9%	3200'			122.90%	
Y51	277°	18.1%	3300'			122.90%	
C35	095°	21.8%	4800'			122.80%	
82C	042°	23.0%	3600'			122.90%	
KLNR	148°	24.2%	5000'			123.00%	
MOVS	201°	24.9%	5000'			122.80%	

Nearest Page: Airport Tab

*While in Aviation Mode*

Press **MENU** when the Nearest Page is open to show the Nearest Page options menu. You can **Show Arrows** (or **Show Bearing**) and **Set Airport Criteria**.

## Aviation Nearest Categories

In Aviation Mode, the Nearest Pages contain the following information:

**Airport**—nearest 15; identifier, bearing, distance, length of the longest runway, and common traffic advisory (CTAF) or tower frequency.

**Wx (Airport Weather Sources)**—nearest 15; airport weather sources including AWOS, ASOS, ATIS, and current METAR data.

**VOR (VHF Omnidirectional Radio Beacons)**—nearest 15; identifier, facility type (symbol), bearing, distance, and frequency.

**NDB (Non Directional Beacons)**—nearest 15; identifier, facility type (symbol), bearing, distance, and frequency.

**INT (Intersection)**—nearest 15; identifier, bearing, and distance.

**User (Waypoints)**—nearest 15; name, bearing, and distance.

**City**—nearest 15; name, bearing, and distance.

**ARTCC (Air Route Traffic Control Center)**—nearest 5; bearing, distance, and frequency.

**FSS (Flight Service Station)**—nearest 5; bearing, distance, frequency, and VOR (for duplex operations).

**Airspace**—up to 15 (based on number of alerts provided); name,

time to entry (when applicable), and status.

## Selecting a Nearby Point as Your Destination

In an emergency, you can press a few keys to have the GPSMAP 496 guide you to the closest point to land.

### To select a nearby point as your destination:

1. Press **NRST**.
2. Use the **ROCKER** to select the sub tab along the top of the page.
3. Highlight the point using the **ROCKER**.
4. Press **Direct To**  $\blacktriangleright$ . The Go To Page opens for the selected point.  
OR  
You can press **ENTER** to show the Information Page (Details Page).
5. Press **ENTER** when **Go To** is highlighted.

### To select the nearest airport as your destination:

1. Press **NRST** twice to show the **Airport** tab and highlight the nearest airport.
2. Press **ENTER** to view airport information.
3. Verify the **Go To** button is highlighted, and press **ENTER**.

## Viewing Details for a Nearby Point

### To view details for a nearby point:

1. Press **NRST** to show the nearest pages. Select the sub tab.
2. Use the **ROCKER** to highlight the item on the list and press **ENTER**. The corresponding information page appears.

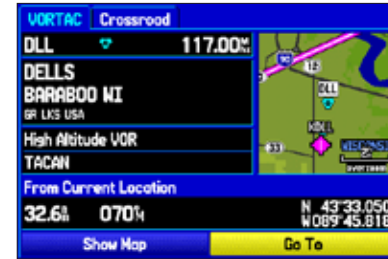

Information Page for a VOR

On airport information pages, use the **ROCKER** to select the sub tabs across the top of the information pages and show the airport data.

3. Press **QUIT** to return to the Nearest Pages. You can also highlight any one of the on-screen buttons to perform that action, such as **Show Map** or **Go To**.

## Viewing Communication Frequencies

The Nearest Pages list up to five nearest flight service station (FSS) and air route traffic control center (ARTCC) points of communication. The closest communication point is shown first, with additional points available when selected. For duplex operation, the corresponding VOR is listed (by identifier) and the transmit and receive frequencies are denoted by a TX and RX respectively.

### To view additional communication frequencies:

1. Press **NRST** to open the Nearest Pages.
2. Use the **ROCKER** to select the **ARTCC** or **FSS** sub tab.
3. Press the **ROCKER** down to highlight **Center** or **Station** (based on which tab you are on), and press **ENTER**.



ARTCC Tab

4. Select the numbered item that you want from the list, and press **ENTER** to show the communication information. The lowest numbers on the list are the closest communication points.

## Viewing Airspace Alert Information

When an airspace alert appears, press **NRST** to automatically show nearby airspace information in the Airspace tab. This information includes name, time to entry (if applicable), and status. Normally, only one or two airspace alerts occur at a time, but with sectorized controlled airspace, such as many Class B areas, there are more. Status information can appear as follows:

**Ahead**—your projected course takes you inside an airspace within the next 10 minutes or less.

**Near**—you are within two nautical miles of an airspace but not projected to enter it.

**Near & Ahead**—you are within two nautical miles of an airspace and your current course takes you inside the airspace.

**Inside Airspace**—you are within the boundaries of the airspace.

## Viewing Additional Airspace Information

From the Nearest Pages, you can show additional airspace information, such as floor and ceiling limits or communication frequencies.

### To view additional airspace information:

1. When an airspace alert appears, press **NRST** to show the Nearest Pages and the airspace information. If you are already viewing the Nearest Pages, use the **ROCKER** to select the **Airspace** tab.

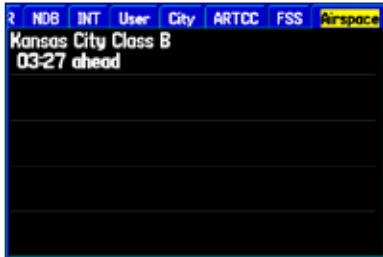

Nearest Pages: Airspace Tab

2. Use the **ROCKER** to select the airspace alert entry on the page, and press **ENTER**. An information page opens to show the controlling agency, status, and floor/ceiling limits.
3. To show a communication frequency for the airspace, select the **Frequencies** button, and press **ENTER**.

To return to the Nearest Pages, select the **OK** button, and press **ENTER**.



**NOTE:** When an airspace alert appears, press **NRST** to automatically show nearest airspace information. Press **NRST** a second time to quickly show the nearest airports list. Press **NRST** a third time to show the Find Menu.

## Setting Airport Criteria

From the Nearest Airport tab, an options window allows you to filter out airports that do not meet a defined criteria. This allows you to only show airports with a surface type and runway length you want. You can also select the **Include Private Airports** and **Include Heliports** check boxes to include private airports and heliports in the Nearest Airport tab.

**Runway Surface**—allows you to set criteria for the type of surface on the runway:

- **Any**—shows any runway, regardless of surface type, including water landing facilities.
- **Hard Only**—shows only runways with a concrete, asphalt, or similar sealed surface.
- **Hard or Soft**—shows all runways except water landing facilities.
- **Water Only**—shows only water landing facilities.

**Minimum Runway Length**—allows you to enter a specific length for the shortest runway allowed.

### To enter airport criteria:

1. Press **NRST**, and open the **Airport** tab.
2. Press **MENU** to show the options menu.

3. Select **Set Airport Criteria**, and then press **ENTER**. A window appears with the current settings for runway surface and minimum runway length.

Airport	Wx	UCR	MOB	TBT	Uvar	City	ARTCD
KATH							
79C							
KGRB							
W34							
W26							
BD1							
KOSH							
92C	008h	22.9%	2500'	122.900'			
KMTW	111h	26.4%	5000'	122.800'			

**Airport Criteria Page**

4. With the runway surface field highlighted, press **ENTER**. Select the surface type, and press **ENTER**.
5. Highlight the minimum runway length field, and press **ENTER**.
6. Use the **ROCKER** to enter the minimum acceptable runway length. Press **ENTER**.



**NOTE:** Use caution when changing the nearest airport criteria. In an emergency, a short runway is still typically preferable to an off-field landing. If you set the runway length too low or exclude many runway surfaces, you may not be alerted to a nearby airport that otherwise would be listed.

## Selecting an Approach



**CAUTION:** The approaches provided in the Jeppesen database are for monitoring purposes only. The GPSMAP 496 is not an IFR-approved instrument and should not be used as a primary source of navigation guidance in instrument conditions.

When you select an approach, it replaces the destination airport with the sequence of waypoints for the selected approach. Keep in mind that the airport must have a published approach (GPS, RNAV, VOR, NDB, localizer, or ILS) and only the final course segment (usually from final approach fix to missed approach point) of the published approach is available in the GPSMAP 496.



**NOTE:** When using a route, the selected approach for the destination airport overrides your current route. The original route is saved in the Route tab.

You can select an approach several ways:

- Press **Direct To**  and press **MENU** on the Go To Page, as described in the steps to the right.
- From the Active Go To (or Active Route) Page, press **MENU**.
- From the Airport Details Page, select the Approach tab.

**To select an approach for the destination airport:**

1. Press **Direct To**  to show the Go To Page. Select the destination you want to travel to.
2. Press **MENU** to open the options menu. Highlight **Select Approach**, and press **ENTER**.
3. Use the **ROCKER** to select the approach from the window, and press **ENTER**. A Vectors? window appears. See the following page for more information on vectors.



Selecting an Approach

4. Use the **ROCKER** to select **Yes** or **No**, and press **ENTER**. The GPSMAP 496 removes the destination airport from the Go To and replaces it with the approach waypoints.

## Understanding Vectors

The Vectors? option, which appears after you select an approach, determines how you navigate to the final approach waypoint.

If you select **Yes**, the GPSMAP 496 creates an extension of the final course, beyond the final approach waypoint in the database (final approach fix [FAF]). On the Active Route Page, a Vector to Final symbol appears beside the first approach waypoint.

Active Approach			
KOSH GPS RW27			
Waypoint	Course	Distance	ETA
→ PEENA	273M	409%	__ : __ A
- RW27		414%	__ : __ A
<b>Total</b>	<b>273M</b>	<b>414%</b>	__ : __ A

### Active Approach Page

*Using vectors in the approach*

The GPSMAP 496 provides no guidance to the inbound course. The course deviation needle on the graphic HSI remains off-center until you are established on this final approach course. The HSI automatically slews (rotates to show the direction) to the inbound course. The Map Page shows an extension of the final approach course using a bold magenta line.

If **No** is selected for the Vectors? option, the GPSMAP 496 creates a straight-line course directly to the first waypoint in the approach (from wherever you are when you initiate the approach). This works much like any other route with course guidance from point to point. A turn usually required as you cross each waypoint.



**CAUTION:** Steep Turns are not allowed on an IFR (Instrument Flight Rules) approach. Follow the approach plate or air traffic control instructions to complete the approach without a steep turn.

If air traffic control clears your approach to an airport, loading the approach cancels your Direct To and initiates a route to the FAF. Load the approach only when cleared by air traffic control.

### To cancel the vectors and/or approach:

1. Press **Direct To**  $\rightarrow$ , and press **MENU** on the Go To Page.  
OR  
From the Active Go To (or Active Route) Page, press **MENU**.
2. Highlight **Cancel Approach**, and press **ENTER** to cancel the entire approach. If you enabled Vectors, highlight **Cancel Vectors**, and press **ENTER** to navigate directly to the FAF.



## Finding Points on Land

To take full advantage of the trip-planning capabilities of the GPSMAP 496, you can find points on the land and then create a turn-by-turn route (auto-route) to that point. For example, you can find a restaurant to eat dinner at when you land.

### To Find Land Points:

1. Press **Direct To**  $\rightarrow$  to show the Go To Page.
2. Press **MENU** to open the options menu.



Go To Page Options Menu

3. Highlight **Find Land Points**, and press **ENTER**. The Find Menu opens.



Find Menu

4. Press **MENU** to select the search method. For example, if you want to find a land point near your destination, select **Near Destination**, and press **ENTER**.
5. Highlight the find menu icon for the category, and press **ENTER**.
6. Enter the necessary information, such as the restaurant name and press **ENTER**. Refer to [page 58](#) for complete information.
7. Select **Save** to save the location as a waypoint to use later when creating a route. Select **Show Map** to show the location on the map, or select **OK** to return to the search results list.

## Marking a Waypoint

Waypoints are locations or landmarks you record and store in your GPSMAP 496. Press the **ENTER/MARK** to capture your present location to create a new waypoint. You must have a valid 2D or 3D satellite fix to mark your location. Press **MENU** twice and open the GPS tab to view your satellite receiver status.

For more information about editing waypoints, see the “[Editing and Managing Waypoints](#)” section beginning on [page 78](#).

### To mark your present location:

1. Press and hold **ENTER/MARK** until the Mark Waypoint Page appears.
2. To accept the waypoint with the default name (“Waypoint”), use the **ROCKER** to highlight **OK**, and press **ENTER**.

### To mark a selected location as a waypoint:

1. Press **PAGE** to open the Map Page.
2. Use the **ROCKER** to move the arrow to the location you want to save as a waypoint.
3. Quickly press and release **ENTER/MARK** to open the Information Page for the map item.



Saving the Selected Item as a Waypoint

4. To save the waypoint, use the **ROCKER** to highlight **Save**, and press **ENTER**.
5. To accept the waypoint with the default name, highlight **OK**, and press **ENTER**.

## Creating a Flight Plan (Route)

You can create a Flight Plan (or route) using the Route Page in the Main Menu. The Route is then saved for future use. You can also create a route using the Active Route Page for immediate use. For more information, refer to “[Creating Routes](#)” beginning on [page 61](#) and “[Editing and Managing Routes](#)” beginning on [page 74](#).



**NOTE:** After you perform an update to your Jeppesen Database, verify that all of your flight plans in your unit are still current. If there is an obsolete Jeppesen aviation point in a saved route, the route is locked and unusable. You need to create a new route with current Jeppesen database points.

### To create a route:

1. Press **MENU** twice to open the Main Menu.
2. Use the **ROCKER** to highlight **Routes**, and press **ENTER**.
3. Press **MENU** to show the options menu. Use the **ROCKER** to highlight **New Route**, and press **ENTER**, or highlight the first blank line, and press **ENTER**.
4. Press **MENU** to show the options menu. Use the **ROCKER** to highlight **Add Waypoint**, and press **ENTER**.  
OR  
Highlight the first blank line, and press **ENTER**.
5. The Aviation Find Page (Go To Page) opens allowing you to select an aviation point. Enter the ID, Facility name, or city.

6. Highlight the point in the list. Highlight **OK**, and press **ENTER**. The selected point is added to the route.

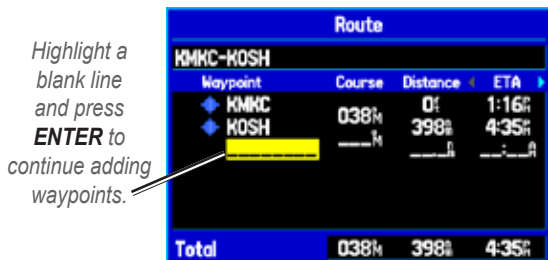

7. Continue steps 4 through 6 until all points are added to the route. The route is automatically saved to the unit's memory.

### To navigate a saved route:

1. Press **MENU** twice to open the Main Menu.
2. Use the **ROCKER** to highlight **Routes**, and press **ENTER**.
3. Highlight the route you want to take from the list, and press **MENU**.
4. Highlight **Activate Route**, and press **ENTER**.

You can also create a flight plan to use at a later time. For more information, refer to “[Creating Routes](#)” beginning on [page 61](#) and “[Editing and Managing Routes](#)” beginning on [page 74](#).

## Following your Flight Plan

When you have created and started your flight plan (or route), the GPSMAP 496 guides you to the destination using a variety of tools.



**NOTE:** After you perform an update to your Jeppesen database, verify that all of your flight plans (routes) in your unit are still current. If there is an obsolete Jeppesen aviation point in a saved route, the route is locked and unusable. You need to create a new route with current Jeppesen database points.

## Track Your Progress on the Map Page

On the Map Page, your current location is shown as an airplane (when in Aviation Mode). You can see how the airplane moves across the map; this is a graphic view of your flight. Your route is marked with a magenta line. The airplane should be on top of the magenta line as you move. When you are on the magenta line, you are directly on course. For complete information about the Map Page and the features of the Map Page, see [pages 29–36](#).



**NOTE:** In Aviation (and Marine) Mode, the Go To line and navigation guidance are fixed. The From point is the location where the Go To was initiated. In Automotive Mode, the Go To line on the map is constantly updated to your present location.

## Terrain and Obstacle Changes

Press **PAGE** to open the Terrain Page, and watch the changes in the terrain and the obstacles you are flying over with the Terrain Page. Terrain and obstacles that are less than 100 feet from your aircraft are shown in red. For complete information, see [page 37](#).

## View the HSI on the Panel Page

You can use the Panel Page to view the HSI, your bearing to the course, and other information such as speed, altitude, and ETA. Use the compass in the center of the page to determine if you are on the proper course. Also, you can help keep the aircraft within the VNAV profile when viewing the VNAV indicator. For complete information about the Panel Page, see [pages 40–43](#).

## Alerts



As you travel, a variety of alerts appear on your current page, such as Airspace, Terrain, Obstacle, and Descent Rate Alerts. When an Airspace Alert pops up, press **NRST** to view the Airspace Information. When a Terrain or Obstacle alert pops up, press **PAGE** or **NRST** to open the Terrain Page. From here you can view any terrain and obstacles that might become a problem to you. Possible points-of-impact are shown as Xs. Adjust your altitude to avoid the obstacles and terrain.

## Aviation Mode Pages

This section discusses the major pages, such as the Map and Terrain Pages, as well as some additional aviation features, such as E6B.

### Map Page

The GPSMAP 496 features a real-time moving map that can do much more than just plot your course. The Map Page shows map information (digital cartography) that includes airspace boundaries, airports, nav aids, lakes, rivers, coastlines, cities, and highways. Dedicated zoom keys (**IN** and **OUT**) are provided for range adjustments.

Two basic map operating modes, location mode and pan mode, determine what cartography is shown on the Map Page. Location mode pans the map to keep your present location in the screen area. The location marker (icon) that shows your travel on the Map Page is an aircraft symbol  in Aviation Mode and a triangle symbol  in Marine and Automotive modes. The GPSMAP 496 always turns on in location mode, with the last known location centered on the map. When you press the **ROCKER**, the GPSMAP 496 enters pan mode, which moves the map to keep the white arrow  (map pointer) within the screen area.

In Aviation Mode, by default, four user-selectable data fields appear in the corners of the screen that can be configured to show any one of the several data options. You can also change the layout of the map and data fields. See [page 34](#) for information.

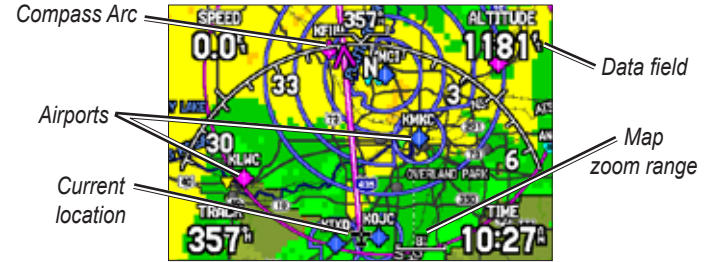

Map Page (Aviation Mode)

A navigation arc (Horizontal Situation Indicator, or HSI) appears by default on the Map Page. The arc works like the compass on the Panel Page, indicating the course and your deviation left or right of this course. If the route line and magenta arrow are heading straight up, you are heading directly to your destination.



**NOTE:** The navigation arc only shows up in Aviation Mode when the Map Page is set to Track Up. See [page 34](#).

## Map Orientation

There are three map orientation options: North Up orients the map like a paper map, Track Up orients the map in the direction of travel, and Course Up orients the map in the direction of the destination. When using Track Up or Course Up, the North arrow indicates the orientation. To change the map orientation, press **PAGE** to open the Map Page. Press **MENU**. Select **Set up Map**, and press **ENTER**. Refer to [page 34](#) for information.

## Selecting Map Ranges

The Map Page has 28 available range scales from 20 ft to 800 nm (20 ft to 800 mi or 5 m to 1200 km). The map range is controlled by the **IN** and **OUT** keys, with the current range shown at the bottom right of the data window.



**NOTE:** The range value represents the distance between the ends of the range bar (3<sup>m</sup>).

### To select a map zoom range (zoom in and out):

- Press the **OUT** key to zoom out.
- Press the **IN** key to zoom in.

The system has a built-in City Navigator street mapping data. Detailed marine chart coverage is available through the use of the BlueChart, or MapSource software.

Map coverage conforms to the following conditions:

- Cartography is shown when the selected zoom range is covered by either the internal map data or other MapSource data loaded onto a data card.
- When the selected zoom range is covered by both the internal map data and data card map information, the cartography with the best resolution is shown.
- When the selected zoom range exceeds the resolution of the data in use, “overzoom” appears below the map range detail of the built-in City Navigator map data.

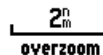

*Using the built-in City Navigator maps.*

- When internal City Navigator map data is used, “detail map” appears below the map range.



*Using the built-in City Navigator maps.*

## Panning the Map

The panning arrow  allows you to pan the map to show other map areas. As you pan past the edge of the current map, the screen moves to provide continuous map coverage.

### To pan the map:

Press up, down, right, or left on the **ROCKER**. The panning arrow moves the map so you can view different parts of the map.



### Panning the Map



### AOPA Service Icon Legend

As you move the arrow, the distance and bearing from your present location to the arrow is shown in the data window, along with the arrow's location coordinates. When you zoom in pan mode, the

*GPSMAP 496 Owner's Manual*

arrow stays centered on the screen. When the arrow is stationary, fixed coordinates appear in the location field, and the distance and bearing from your present location update as you move.

### To re-center your location on-screen:

1. When you are finished panning the Map, press **QUIT**.
2. The map automatically moves to show your present location, and the unit returns to location mode.

The arrow can also be used to select on-screen map items, allowing you to review a selected item directly from the map screen.

### To view details about an on-screen point:

1. Use the **ROCKER** to move the arrow to the waypoint or map item you want. If there are several items grouped closely together, zoom in closer for a better view.

When a waypoint or map item is selected, it is highlighted on screen with the name and location shown at the top of the screen, along with the distance and bearing from your current location, as shown in the image to the left.

2. Press **ENTER** to view more information about the point. The information and on-screen buttons shown vary based on the type of item selected. In some cases, additional information tabs appear at the top of the Information Page or Waypoint Page.
3. Use the **ROCKER** to highlight the extra tabs and view the information.
4. Select an on-screen button, and press **ENTER**.
5. Press **QUIT** to exit the Information Page.



Airport Information Page

## Smart Airspace

Smart Airspace shows airspace at and immediately surrounding your current altitude in bold. Airspaces at all other altitudes are de-emphasized.



Smart Airspace on the Map Page

## Airspace Information

Pan mode can also be used to retrieve information on airspaces depicted on the map.

*Highlighted  
airspace area*



Airspace Information

*Information box  
with airspace  
name, type,  
and floor/ceiling  
limits*

### To retrieve airspace information from the Map Page:

1. Use the **ROCKER** to select an area within the airspace boundary. The boundary line is highlighted and the airspace type and floor/ceiling limits are shown.
2. To show additional information, press **ENTER**.  
View communication frequencies by highlighting the on-screen **Frequencies** button, and pressing **ENTER**.
3. To return the to Map Page, highlight **OK**, and press **ENTER**.



## Clearing Unwanted Details from the Map

You can remove items from the map (declutter the screen) to remove unwanted items, such as highways. Aviation Mode has various levels of declutter.

To quickly declutter the map, press **ENTER**. You can also declutter the map on the Terrain Page.

### To declutter the Map Page:

1. From the Map Page, press **ENTER**. **Clear-1** appears under the map range. The background map detail—including highways, cities, rivers & smaller lakes—is removed from the map.
2. Press **ENTER** again. Airspace boundary detail is removed from the map. **Clear-2** appears below the map range.
3. Press **ENTER** again. Only the waypoints and navaids that are part of the current Go To or route appear on the map. **Clear-3** appears below the map range.
4. In Aviation Mode, press **ENTER** again to return ALL detail to the map.

In Marine and Automotive Modes, press **MENU**, highlight **Declutter On** or **Declutter Off**, and press **ENTER**.

## Measuring Distance

You can measure the distance and bearing between two map items.

### To measure the bearing/distance between two points:

1. From the Map Page, press **MENU** to open the options menu.
2. Highlight the **Measure Distance** option, and press **ENTER**. An on-screen arrow appears on the map at your present location with **ENT REF** below it.
3. Move the arrow to the reference point (the starting point that you want to measure from), and press **ENTER**. A push-pin icon marks the starting point on the map.



**Measure Distance**

4. Move the arrow to the point want to measure to. The bearing and distance from the reference point and arrow coordinates appear in the data window at the top of the screen.
5. Press **QUIT** to finish.

## Setting the Bug Indicator

You can set a bug indicator to show bearing or course to steer. You can also enter a specific heading reference for the indicator.

### To set the Bug Indicator:

1. From the Map Page, press **MENU** to open the options menu.
2. Use the **ROCKER** to highlight **Set Bug Indicator** and press **ENTER**.
3. A list of Bug Indicator options appears. By default, the bug indicator shows **Bearing** (BRG) to waypoint, but can also show the **Course to Steer** (CTS) or can be **User Selected**. The **User Selected** option allows you to mark a heading reference on the graphic HSI. This provides a visual cue of an important heading for current or future use. You can also turn the Bug Indicator off here.
4. Highlight the option from the list, and press **ENTER**.

You can also set the Bug Indicator on the HSI shown on the Panel Page. Open the Panel Page and press **MENU**. Follow steps 2 through 4 above.

## Setting Up the Map Page

The Map Page Setup allows you to adjust the way items appear on the Map Page.

### To change a map setup option:

1. From the Map Page, press **MENU** to open the options menu.
2. Highlight **Set up Map**, and press **ENTER**.
3. Press left or right on the **ROCKER** to highlight the tab, then up or down on the **ROCKER** to highlight to the field you want to change, and press **ENTER**.



General Tab of the Map Page Setup

4. Press up or down on the **ROCKER** to highlight to the setting, and press **ENTER** to select the new setting.
5. Press **PAGE** or **QUIT** to exit.

## Changing the Page Layout and Data Fields

To customize the pages to show what you want, adjust the page layout and data fields.

You can adjust how the following pages look on the screen: Map, Terrain, Panel, Compass, Highway, Location Data, Trip Computer, and optional Sonar Page. You can adjust the data fields on many of these pages as well.

### To set up the page layout:

1. Press **PAGE** to show the page you want to change.
2. Press **MENU** to open the options menu.
3. Highlight **Set up Page Layout**, and press **ENTER**.



*Changing the layout of the Map Page*

### To change a data field:

1. Press **PAGE** to show the page you want to change.
2. Press **MENU** to open the options menu.
3. Highlight **Change Data Fields**, and press **ENTER**
4. Move the field highlight to the data field you want to change, and press **ENTER**.
5. Press up or down on the **ROCKER** to highlight the data you want to show, and press **ENTER**.
6. To return the field to the default setting, press **MENU** and then **ENTER**.
7. Press **QUIT** to exit.

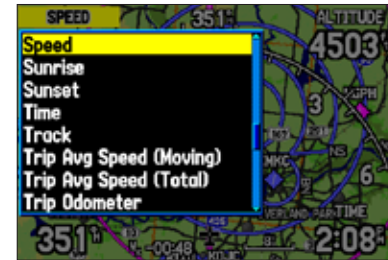

*Changing a Data Field*

4. Select the option you want, and press **ENTER**. The options vary between the three usage modes and the page you are setting up.

## Additional Map Data

You can view the data that is currently loaded on your GPSMAP 496 unit and data card.

### To review or change data card information:

1. Access the Map Page, and press **MENU**.
2. From the options menu, highlight **Map Information**, and press **ENTER**.

*Map Family highlighted. Press **ENTER** to view the individual maps in the family.*



**Map Card Information Page**

3. The first page shows the Map Families that are stored on the data card and whether they are shown on the Map Page.  
To change the setting for a Map Family, highlight the box next to the Map Family name, and press **ENTER** to select (check mark) or deselect (no check mark) the **Show** setting.
4. To view the list of maps within a Map Family, highlight the name of the Map Family, and press **ENTER**.
5. To view detailed information about an individual map, highlight the Map Name, and press **ENTER**. Highlight **OK**, and press **ENTER** to exit the map information page.
6. To select or deselect individual maps, highlight the box next to a map, and press **ENTER** to check or uncheck the **Show** box.  
OR  
Press **MENU**, and select one of the options (**Show All**, **Hide All**, or **Show Defaults**), and press **ENTER**.
7. Press **QUIT** to exit the Map Information Page.

## Terrain Page

The Terrain Page, available only in Aviation Mode, provides an overhead view of the terrain and obstacles beneath you. Alert windows appear on all pages to inform you of your proximity to the terrain and obstacles, as well as an unsafe descent rate. These alerts depend on user-defined parameters in the Terrain setup.

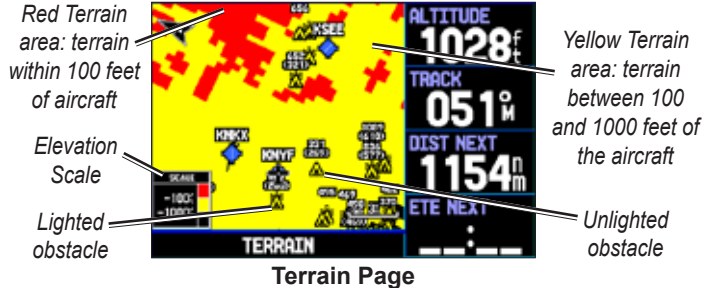

## Terrain Information

The areas of the terrain shaded red are predicted to be within 100 feet below or above the aircraft. The yellow terrain areas are between the user-defined **Caution Elevation** and 100 feet below the aircraft. By default, the **Caution Elevation** is 1,000 feet; therefore, the areas in yellow are between 1,000 feet and 100 feet below the aircraft. The black areas are further than the **Caution Elevation**. A projected point of impact is marked with an “X” symbol.

## Obstacle Information

Obstacles are shown on the Terrain Page at or below the map range of 12 nm. Obstacles are also shown on the Map Page when the map range is set to 3 nm or below.

Standard aeronautical chart symbols are used for lighted or unlighted obstacles taller than 200 feet Above Ground Level (AGL). Refer to the Obstacle Icons legend below.

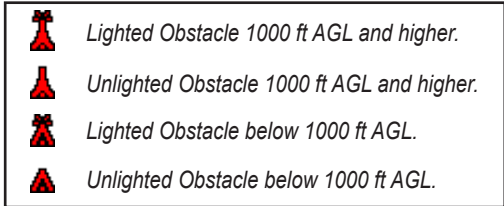

**Obstacle Icons**

Each obstacle is labeled with the altitude of the top of the obstacle, or Mean Sea Level (MSL). Each obstacle also lists, in parentheses, the actual height of the obstacle, or Above Ground Level (AGL).

## Terrain and Obstacle Color Code

**Red**—terrain or obstacle is within 100 feet of the aircraft.

**Yellow**—terrain or obstacle is between the user-defined **Caution Elevation** and 100 feet below the aircraft.

## Alerts

If you are on another page of the GPSMAP 496 unit, Terrain, Obstacle, and Descent Rate Alerts show in the lower-left corner to inform you of the situation. The alert remains on the screen until the flight path has cleared the obstacle or terrain, or until you press QUIT.



**Obstacle Warning**

*Shown on the Panel Page*

## Additional Terrain Page Options

Access the Terrain Page options menu by pressing **MENU** while you are on the Terrain Page.

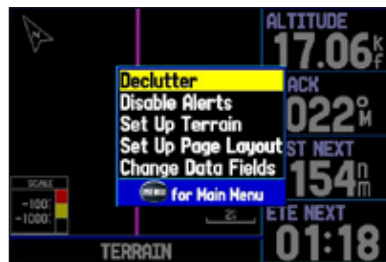

**Terrain Page Options Menu**

- Press **ENTER** to quickly declutter the map, just as you would on the Map Page. See [page 33](#).
- To quickly disable alerts, highlight **Disable Alerts** and press **ENTER**. Repeat to enable alerts again.
- You can pan the map and zoom in and out using the same techniques you use on the Map Page. See [page 30](#).
- You can change the layout of the Terrain Page. Refer to [page 37](#). Also, refer to [page 174](#), for information about the data fields.

## Setting Up the Terrain Page and Alerts

Use the Terrain Setup Page to set levels for terrain alerts as well as obstacles in or near your flight path.

### Caution Elevation

Select the **Caution Elevation**. If the terrain or an obstacle is within the **Caution Elevation** you entered, the GPSMAP 496 provides an alert.

### Look Ahead Time

The **Look Ahead Time** for Terrain and Obstacle Alerts determines the time when an alert annunciation occurs. For example, if 120 seconds is selected, the GPSMAP 496 provides an alert up to 120 seconds before you reach the terrain or obstacle.

### Alert Sensitivity

The three Alert Sensitivity settings (**Terrain**, **Obstacle**, and **Descent Rate**) determines what level of alerts are annunciated. The GPSMAP 496 defaults to **High** sensitivity, which annunciates all red and yellow alerts at the time set in **Look Ahead Time**. **Medium** sensitivity annunciates all of the red and the highest priority of yellow alerts, and **Low** only annunciates red alerts.

### To set up the Terrain Page:

1. On the Terrain Page, press **MENU** to access the Terrain Page options menu.
2. Select **Set up Terrain**, and press **ENTER**.



Terrain Setup Page

3. Make the adjustments to the Terrain Setup Use the **ROCKER** to select options, and press **ENTER**. Select an option, and press **ENTER**.
4. Press **PAGE** or **QUIT** to accept the changes and exit the Set up Terrain Page.

## Panel Page

The Panel Page shows GPS-derived data in a graphical format, similar to an instrument panel. Keep in mind the differences between this page and your mechanical instruments, as your mechanical panel instruments use sensors that provide information different from that derived using GPS. The Panel Page appears only when the GPSMAP 496 is in Aviation Mode.

The Panel Page shows a graphic Horizontal Situation Indicator (HSI) surrounded by additional indicators.



The graphic HSI depicts the course to the destination or the next waypoint in a route, current ground track, off course error, and a To/From indication. The rotating compass indicates your current ground track at the top of the page.

The course pointer and course deviation needle indicate the course and whether you are on the course. A bug indicator provides information to guide you back to the course if you stray off course.

If you move off course, the Course Deviation Indicator, or needle, indicates how far off course you are, left or right, based on its placement along the course deviation scale. To get back on course and center the needle, steer toward the needle.

The course deviation scale setting is adjustable for Auto,  $\pm 0.25$ , 1.25 or 5.0 (nautical mile, statute mile, or kilometer) full-scale deflection. The course deviation scale appears on the lower right corner of the HSI. The default setting is Auto, which uses three factors to determine the distance from the center of the CDI to full left or right limits:

- When you are within 30 nm of any airport in the active route, Auto sets the CDI scale at 1.25.
- When you are on an approach leg or within 2 nm of the FAF or MAP waypoints, Auto sets the scale at 0.25.
- If the previous two conditions do not exist, Auto sets to 5.0.



## Setting Up the Panel Page

You can set the bug indicator and change the CDI scale to suit your needs.

### To set a user-defined bug heading reference:

1. When the Panel Page appears, press **MENU** to show the Panel Page options menu.
2. Highlight **Set Bug Indicator**, and press **ENTER**.
3. Highlight **User Selected**, and press **ENTER**. A window appears at the center of the HSI, showing the current bug indicator setting.
4. Select the heading reference by pressing left or right on the **ROCKER**. Press **ENTER**. The bug indicator remains fixed on the selected heading until a new bug heading is chosen.

### To change the CDI scale:

1. With the Panel Page shown, press **MENU** to show the Panel Page options menu.
2. Use the **ROCKER** to highlight **Set CDI Scale**, and press **ENTER**. A window appears at the center of the HSI, showing the scale settings. The current setting is highlighted.
3. Use the **ROCKER** to select the scale, and press **ENTER**.

## Manually Setting a Course

Use the **Set OBS and Hold** option to manually set your course to the destination.

### To manually set a course to the destination waypoint:

1. With the Panel Page shown, press **MENU** to show the Panel Page options menu.
2. Highlight **Set OBS and Hold**, and press **ENTER**. An OBS data field appears on the screen. Keep in mind that you must have a destination waypoint selected.
3. Select the OBS course by pressing the **ROCKER** left and right. Press **ENTER**. The course deviation needle and course pointer now provide steering guidance to the selected course.

To release the waypoint hold and return to automatic sequencing of route waypoints, press **MENU**. Highlight **Release Hold**, and press **ENTER**.

To cancel the OBS course and reset a direct course to the waypoint, press **Direct To** , highlight **Resume Route**, and press **ENTER** to re-start the route.

## VNAV (Vertical Navigation)

The VNAV sub tab in the Main Menu provides settings for the vertical navigation feature. These settings create a three-dimensional profile that guides you from your present location and altitude to a final (target) altitude at a specified location.

When the VNAV profile is defined, message alerts help keep you informed of your progress. The teal bar on the HSI on the Panel Page shows your VNAV profile.

To use the vertical navigation feature, your ground speed must be greater than 35 knots and you must be navigating a Go To or a route.

The “Approaching VNAV Profile” message appears one minute prior to the initial descent point. The descent angle locks to prevent changes in speed from altering the profile. The VNAV feature does not take into account any changes in groundspeed that occur during the transition from level flight to descent or climb.

At 500 ft above the target altitude, the “Approaching Target Altitude” message appears, the time to vertical navigation goes blank, and the VNAV indicator disappears from the Panel Page.



**CAUTION:** The GPSMAP 496 is a VFR navigation tool and should not be used to perform instrument approaches. VNAV is only a VFR navigation aid and is not intended for instrument approaches.

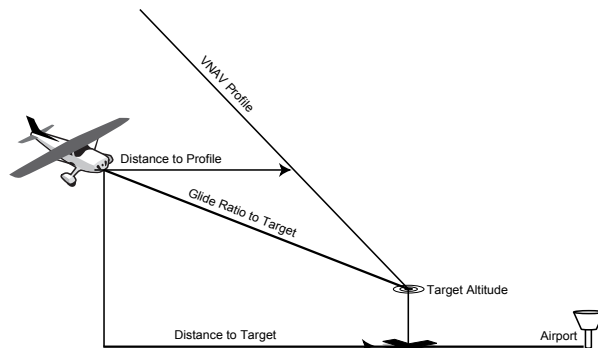

**Visual representation of VNAV**

## Using the VNAV Feature

Use the VNAV (Vertical Navigation) feature to ensure that you are flying at the proper altitude. The VNAV Indicator appears on the HSI (Panel Page) as a horizontal teal bar, as shown in the image on the next page. A message appears when you are approaching the VNAV Profile. When the bar is in the vertical center of the HSI, you are at the proper altitude for the VNAV Profile. Make sure **VNAV Indicator** is **On** in the options menu. From the Panel Page, press **MENU** to open the options menu. Select **Capture VNAV Profile**, and press **ENTER** to center or re-center the VNAV indicator on the graphic HSI. You must have entered a valid vertical navigation profile and be navigating.



Panel Page Showing the VNAV Indicator

VNAV indicators also appear on the Map Page when the page layout is set to **Map With Overlay**. You are at the proper altitude for the VNAV profile when the blue bars are centered within the VNAV indicators.



Map Page Showing the VNAV Indicator

## Setting up VNAV

To open the VNAV tab, press **MENU** twice to open the Main Menu. Select **Setup** from the vertical tab list. Then select **VNAV** from the row of tabs along the top of the page.

The VNAV Waypoint automatically changes to your destination after you begin navigating to a destination.



VNAV Setup Tab

**Target Altitude**—enter the altitude you want to be at when you reach your target location. Select **Above Waypoint** to use field elevation for airports in the Jeppesen database or **Above MSL** to specify an exact MSL altitude target.

**By**—defines the target location with settings of distance **Before** or **After** a reference waypoint (the final destination airport). To set a target location at a reference waypoint, enter a distance of zero.

**VNAV Waypoint**—allows you to select any waypoint along the currently active route (or Go To) as your reference waypoint. The reference waypoint defines the target location.

**VNAV Profile**—allows you to select the descent rate.

**VNAV Messages**—enables and disables VNAV alert messages.

## Active Route Page

Whenever you start a route (flight plan) or initiate a Go To while in Aviation or Marine Mode, the Active Route Page shows each point (waypoint or map item) of the active route, with the point name, Course, Distance, and several other fields of information. The current destination point, the active point, is marked with an arrow. As you navigate a route, the list automatically updates to indicate the active point first. The Active Route and Route Review Pages share many of the same features and options.

Press **PAGE** repeatedly to open the Active Route Page.

Active Route			
KOJC-KSTJ			
Waypoint	Course	Distance	ETA
▶ KOJC	359M	---	---
▶ KMCI	339M	20.5M	---
▶ KSTJ	---	50.4M	---
Total		349M	50.4M

Active Route Page



**NOTE:** If you have created a route (Flight Plan) with a Jeppesen point that is no longer current after you perform an update to your Jeppesen database, the route is locked. You need to create a new route with current Jeppesen database points.

## Active Route Page Options

Press **MENU** while on the Active Route Page to open the options menu. You can edit the route using many of the options in the menu such as **Edit on Map** (see [page 77](#) for information), **Add Waypoint**, and **Invert**. You can also change the data fields to suit your needs.

You can also select an approach for your landing and set your fuel flow (or plan your route, based on your current Usage Mode):

**Select Approach**—(Aviation Only) allows you to select the final course segment of a published approach, replacing the final destination airport in a Go To or route with the sequence of waypoints for the selected approach. The approaches provide only the final course segment, usually from final approach fix (FAF) to missed approach point (MAP), and are based on existing GPS, RNAV, VOR, NDB, localizer, or ILS approach procedures. All approach procedures are flown as a sequence of waypoints in the route. To select an approach and add the waypoints to the route, the final destination in the Go To or route must be an airport with a published approach.

**Set Fuel Flow (Plan Route)**—allows you to enter information about your aircraft and route.

## Position Data Page

The Position Data Page provides a quick reference for the important data you want to show while navigating a route in Aviation and Marine Modes. The default page shows a compass ribbon, your current latitude and longitude, the current date and time, the location you are in reference to the nearest landmark, and eight user-selectable data fields. The compass ribbon is shown at the top of the page to show your current heading with a red, vertical bar. To stay on course, steer toward the violet bar (or arrows) until it is aligned with the red bar.

Press **PAGE** repeatedly to open the Position Data Page.

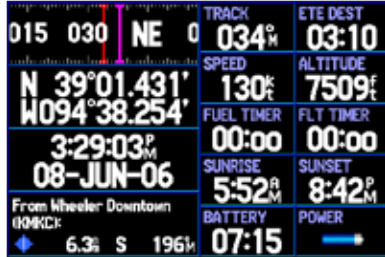

**Position Data Page**

*Airport is selected as the Nearest Type. The Wheeler Downtown (KMKC) airport is the nearest airport, and you are 6.3 nm S of KMKC.*

## Position Data Page Options

With the Position Data Page open, press **MENU** to open the options menu. You can set up the layout of the page and change the data fields. For an explanation of the data fields, refer to [page 174](#). You can also select one of the following options:

**Change Nearest Type**—allows you to specify the type of item to be used as the nearest item (shown in the lower-left data field). The choices differ based on the Usage Mode you are currently using. Choose **Automatic** to allow the unit to pick the appropriate type of landmark for your present location.

**Reset Trip**—clears trip information, except the maximum speed and the odometer.

**Reset Max Speed**—clears the maximum speed.

**Reset Odometer**—clears the running total of the distance traveled since the odometer was last reset.

**Reset All**—clears all trip information including the maximum speed and odometer.

## Flight Log

The Flights tab shows a list of any recorded flights, including date, route of flight, and flight time. The GPSMAP 496 saves up to 50 recorded flights while in Aviation Mode. Entries on this list are automatically created for each flight.

The bottom of the Flights tab shows the time of your last flight. This resets if you select **All Unit Defaults** from the System tab options menu.

An optional FlightBook software package is available to further simplify your flight record keeping. For details about FlightBook, visit the Garmin Web site at [www.garmin.com/aviation](http://www.garmin.com/aviation).

### Viewing the Flight Log

Recording begins when your speed exceeds 30 knots and you gain 250 feet of altitude. The **Route of Flight** field uses the nearest airport as the departure airport. The destination airport is continuously updated as your flight progresses.

If you land and groundspeed drops below 30 knots, the flight entry is saved and a new entry is recorded when you depart the airport. A touch-and-go or brief stop of less than 10 minutes appends to the current flight record, rather than starting a new entry.

Select any listed entry in the log to view additional information.

### To view details for a flight:

1. Press **MENU** twice to open the Main Menu.
2. Highlight **Flights** from the vertical menu of tabs.
3. Press **MENU** and select **Show Hours and Minutes** to view the flights in minutes and hours, if you prefer.
4. Highlight the flight, and press **ENTER**. The flight details window opens, shown below.
5. With **OK** highlighted, press **ENTER** to return to the Flights tab.



**Flight Tab**

*Showing the flight details page*

### Deleting Flight Records

You can delete the highlighted flight record (**Delete Flight**) or delete all flight records from the Flight Log (**Delete All**). To delete flights, press **MENU** (with the Flights tab information shown). Use the **ROCKER** to highlight a menu option, and press **ENTER**.

## Aircraft Information

The Aircraft tab is divided into two sub tabs: Aircraft Profile and Weight & Balance.

### To open the Aircraft tab:

1. Press **MENU** twice to open the Main Menu.
2. Highlight **Aircraft** from the vertical list of tabs.
3. Press the **ROCKER** right or left to highlight either the **Aircraft Profile** tab or the **Weight & Balance** tab from the top of the screen.



Aircraft Profile Tab

## Entering Your Aircraft Profile

The Aircraft Profile tab allows you to profile cruising speed, maximum speed, fuel flow, and map symbol. The unit can save up to 10 aircraft profiles.

Cruising speed and fuel flow are used as default settings when viewing trip planning information on the Route Review Page. The maximum speed is used to define the range for airspeed on the Panel Page and is automatically updated if you exceed this figure.

### To enter an aircraft profile:

1. From the Aircraft Profile tab, use the **ROCKER** to highlight **New**, and press **ENTER**.
2. Highlight the **Current Aircraft** field, and press **ENTER**.  
OR  
Highlight the **Rename** button, and press **ENTER**.
3. Use the **ROCKER** to enter the aircraft tail number (or other identifying information) in the **Current Aircraft** field. Press **ENTER** when finished.
4. Use the **ROCKER** to enter information for the cruising and maximum speeds for your aircraft, your aircraft's fuel flow, and the symbol for your aircraft.  
  
Select a symbol for your aircraft to change the data fields on the Panel Page and the map symbol.

### To select a saved aircraft profile:

1. From the Aircraft Profile tab, use the **ROCKER** to highlight the **Current Aircraft** field, and press **ENTER**.
2. Use the **ROCKER** to select the aircraft profile, and press **ENTER**.

**To rename or delete a saved aircraft profile:**

1. From the Aircraft Profile tab, use the **ROCKER** to highlight the **Current Aircraft** and to select the profile you want to rename.
2. Use the **ROCKER** to select the on-screen **Rename** or **Delete** button, and press **ENTER**. If **Rename** is selected, use the **ROCKER** and **ENTER** keys to enter a new tail number.

**Calculating the Weight & Balance**

Weight & Balance may be used during your pre-flight preparations to verify the weight and balance conditions for your aircraft. By entering the weight and arm values on this page, the GPSMAP 496 can calculate the total weight, moment, and center of gravity (CG) to ensure a safe flight.

Before entering the various figures, you need to determine the empty weight of the airplane and the arm (or “station”) for each weight entered. These figures should be determined using the pilot’s operating handbook for your airplane, which also notes the weight limitations and fore/aft CG limits. Compare those figures to the values calculated by the GPSMAP 496.

**To perform weight and balance calculations:**

1. Press **MENU** twice to open the Main Menu.
2. Highlight **Aircraft** from the vertical list of tabs.
3. Press the **ROCKER** right to highlight **Weight & Balance**.



ITEM	WEIGHT	ARM
Aircraft	0.00	0.000
Usable Fuel	0.00	0.000
Pilot	0.00	0.000
Copilot	0.00	0.000
Passenger	0.00	0.000
Passenger	0.00	0.000
Baggage	0.00	0.000
Other	0.00	0.000
Other	0.00	0.000
MOB.WT	0.00	0.000
CELESTIAL	0.00	0.000

**Weight & Balance Tab**

4. Highlight the **weight** field, and press **ENTER**.
5. Use the **ROCKER** to enter the weight figure. Press **ENTER**.
6. Change the weight units. Highlight **lbs**, and press **ENTER**.  
OR  
Select **Kgs**, and press **ENTER**.
7. Highlight the corresponding **ARM** field, and press **ENTER**.
8. Use the **ROCKER** to enter the arm figure. Press **ENTER**.
9. Repeat steps 4 through 8 until all figures are entered. The calculated moment, weight, and CG figures appear at the bottom of the page. Keep in mind that the “Aircraft” (empty weight/arm) figures must be entered as a reference to calculate a valid moment, weight, and CG.
10. To empty the aircraft, press **MENU**, select **Empty Aircraft**, and press **ENTER**.



**NOTE:** This information is only for flight planning purposes. Consult your aircraft’s pilot handbook for the official weight and balance data.



## E6B Tab

The E6B tab in the Main Menu calculates Density Altitude, True Airspeed, and Winds Aloft (Head Wind, Tail Wind, Wind From, and Wind Speed), based on information you enter.

### To open the E6B tab of the Main Menu:

1. Press **MENU** twice to open the Main Menu.
2. Highlight **E6B** from the vertical list of tabs.

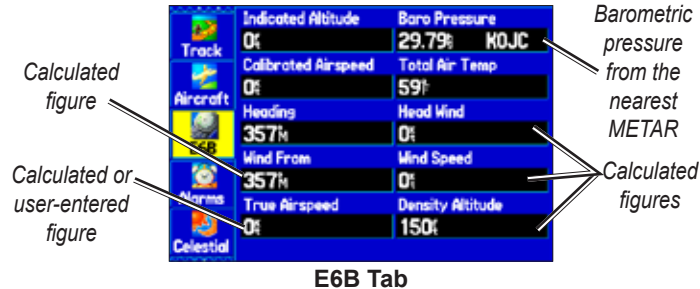

**Indicated Altitude**—required entry for density altitude/true airspeed calculation. Enter the aircraft’s altimeter reading.

**Calibrated Airspeed**—required entry for density altitude/true airspeed calculation. Enter the aircraft’s airspeed indicator.

**Heading**—required entry for winds aloft calculation. Use heading from the aircraft’s heading indicator or directional gyro.

**Baro Pressure**—when the unit is receiving XM weather information, the field automatically updates to the barometric pressure of the nearest METAR. If XM weather information is not available you need to enter the current barometric pressure.

**Total Air Temperature**—required entry for density altitude/true airspeed calculation. Total Air Temperature (TAT) is the temperature of the air including the heating effect caused by speed. The temperature reading on a standard outside air temperature gauge found on most piston aircraft is TAT.

**Head Wind**—(calculated figure) determined from entry of heading and true airspeed.

**Wind From**—(calculated figure) determined from entry of heading and true airspeed.

**Wind Speed**—(calculated figure) determined from entry of heading and true airspeed.

**True Airspeed**—(calculated or user-entered figure) determined from entry of calibrated airspeed, barometric pressure, and total air temperature. This can also be entered directly for winds aloft calculations.

**Density Altitude**—(calculated figure) determined from entry of indicated altitude, barometric pressure and total air temperature.

**To calculate true airspeed and density altitude:**

1. From the **E6B** tab, highlight the **Indicated Altitude** field (at the top of the page), and press **ENTER**.
2. Use the **ROCKER** to enter the altitude shown on your altimeter. Press **ENTER** when finished.
3. Repeat steps 1 and 2 to enter the **Calibrated Airspeed**, **Baro Pressure**, and **Total Air Temperature**. (For **Calibrated Airspeed**, use the speed shown on your airspeed indicator. Use the current altimeter setting for **Baro Pressure**. **Total Air Temperature** is the temperature of the outside air including the heating effect caused by speed. For most aircraft, this is the temperature reading on a standard outside air temperature gauge.) The calculated figures for **True Airspeed** and **Density Altitude** are shown in the designated fields.

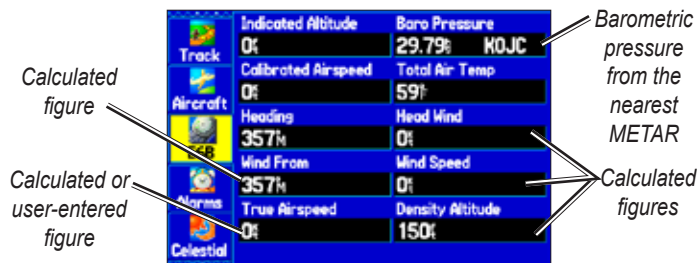
**E6B Tab****To calculate winds aloft:**

1. Follow the steps in the previous procedure to determine true airspeed.  
OR  
Use the **ROCKER** and **ENTER** keys to manually enter a true airspeed figure in the **True Airspeed** field.
2. Use the **ROCKER** to highlight the Heading field, and press **ENTER**.
3. Use the **ROCKER** to enter the aircraft heading shown on your directional gyro or compass. Press **ENTER** when finished.  
The calculated figures for Head Wind, Wind From, and Wind Speed appears.



**NOTE:** If a True North reference is currently selected as the heading reference on your GPSMAP 496, you must enter Heading using a True North reference to determine winds accurately.

**To restore defaults on the E6B tab:**

1. Open the **E6B** tab on the Main Menu.
2. Press **MENU** to open the options menu.
3. Highlight **Restore Default**, and press **ENTER**.

## XM Audio Page

Use the XM Audio Page to view and select XM Radio channels, add channels to or remove channels from the Favorites category, and turn XM audio output on or off.



**NOTE:** You **MUST** have a GXM 30A or GXM 30 smart antenna connected to your GPSMAP 496 and a subscription to XM Radio to use XM Radio features. Additionally, you must use an optional external speaker with vehicle power cable, third-party FM modulator, headphones, or another audio device plugged in to hear the audio.

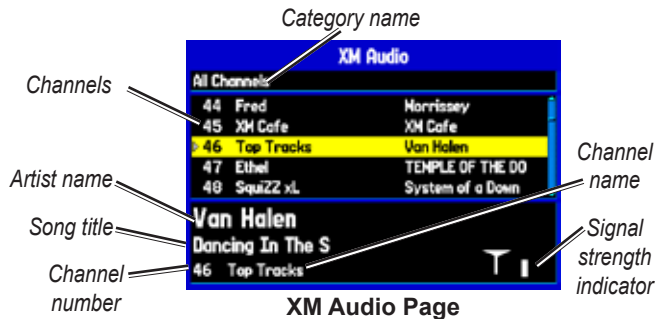

The XM Audio page is available in Aviation, Marine, and Automotive Modes, but it is not shown by default in any mode. However, the XM tab always appears on the Main Menu, even if the XM Audio Page is turned off.

The XM Audio Page is divided into three panes. The first pane contains a list of XM Radio categories into which XM Radio channels are grouped (Classical, Decades, Traffic, and so on). For a complete list of available categories and channels, visit the XM Radio Web site at [www.xmradio.com](http://www.xmradio.com). Select All Channels to view a list of all channels in numerical order. You can also view a list of your favorite channels.

The middle pane shows a list of channels in the selected category. Each channel has a description and the artist currently playing. You can adjust this setting to show the song title instead of the artist. The bottom pane shows the song and artist or program name, the channel number and name, and the strength of the XM Radio signal.

### Turning on the XM Audio Page

The XM Audio Page is off by default.

#### To show the XM Audio Page:

1. Press **MENU** twice to show the Main Menu.
2. Use the **ROCKER** to highlight the **Display** tab.
3. Highlight the **XM Audio Page** field, and press **ENTER**.
4. Select **On**, and press **ENTER**.



**NOTE:** Audio interference can occur while using some aviation audio panels and FM Modulators. Use of a Ground Loop Isolator can eliminate this interference.



XM Audio Page Field on the Display Tab

#### To select an XM Radio channel:

Press up or down on the **ROCKER** to scroll through the list of channels, highlight the channel you want, and then press **ENTER**. A triangle (▷) appears to the left of the channel currently playing.

#### To select an XM Radio category:

Press the **IN** or **OUT** keys to change the category.

OR

Highlight the **category** field, and press **ENTER**. Use the **ROCKER** to change the category.

## XM Audio Page Options

Use the options menu to customize the XM Audio Page. When the XM Audio Page is open, press **MENU** to open the options menu.

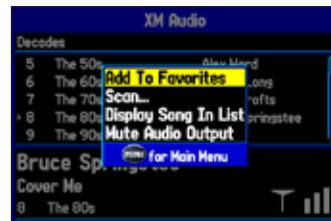

XM Audio Page Options Menu

The following options are available on the XM Audio Page options menu:

**Add to Favorites**—enables you to add channels to the Favorites category. See [page 53](#) for more information.

**Scan**—enables you to scan all channels, scan by category, or scan favorites. Each channel is played for five seconds before advancing to the next channel in the list. For more information see [page 54](#).

**Display Artist (Display Song) In List**—enables you to select whether to display the artist or song title in the channel list.

**Mute/Enable Audio Output**—enables you to toggle XM audio output on or off.

## Using Favorites

You can create a customized list of up to 30 of your XM Radio favorites.

### To add a channel to Favorites:

1. Use the **ROCKER** to select a channel, or use the **IN** and **OUT** keys to select a category, and then highlight a channel.
2. Press **MENU** once.
3. Highlight **Add To Favorites**, and press **ENTER**. Repeat to add additional channels.



**Adding a channel to Favorites**

### To view and select Favorites with the IN and Out keys:

1. Press the **IN** and **OUT** keys to change the category to **Favorites**.
2. Press up or down on the **ROCKER** to highlight the channel you want to select from your list of favorites, and press **ENTER**. A triangle appears to the left of the newly selected channel.

### To view and select Favorites with the ROCKER:

1. Highlight the category field, and press **ENTER**.

2. Use the **ROCKER** to highlight **Favorites**.
3. Press **ENTER**.

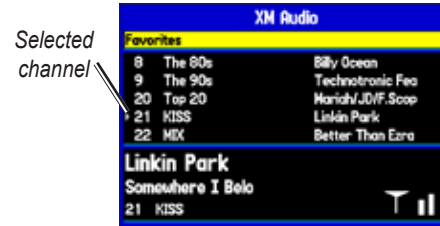

**Favorites List**

You can delete a channel from the Favorites list or delete all channels.

### To delete a channel from Favorites:

1. In the Favorites category, highlight the channel you want to delete, and press **MENU**.
2. Highlight **Delete Favorite** to delete the selected channel from your favorites list.  
OR  
Highlight **Delete All Favorites** to delete all channels from your Favorites list.
3. Press **ENTER**.
4. Highlight **OK**, and press **ENTER** again to confirm.

## Scanning XM Radio Channels

From the XM Audio Page, you can scan all channels, scan channels in a specific category, or scan channels in your Favorites.

### To scan XM Radio channels:

1. On the XM Audio Page, press **MENU**.
2. Select **Scan** on the options menu, and press **ENTER**.
3. Select **All Channels** to scan all channels.  
OR  
Select **Category** to scan only channels in the selected category.  
OR  
Select **Favorites** to scan only channels in your Favorites list.
4. Press **ENTER**. Each channel plays for five seconds, and then advances to the next channel.
5. Press any key to stop scanning and select the current channel.

## Turning Audio On or Off

### To turn audio on or off:

1. On the **XM Audio Page**, press **MENU**.
2. Highlight **Mute Audio Output** on the options menu to turn off the audio. A music note with a red slash appears in the Song pane. Highlight **Enable Audio Output** to resume audio output.

*Audio output is off*

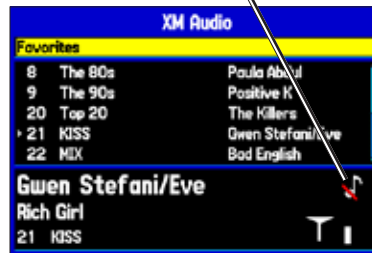

## Basic Operation In Automotive Mode

To switch usage modes:

1. Press and hold **PAGE/MODE**.
2. Use the **ROCKER** to select either **Aviation**, **Automotive**, or **Marine**, and press **ENTER**.

### Automotive Mode Page Sequence

Automotive Mode features two main pages: the Map and Trip Computer Pages. Optional Highway, Compass, and XM Audio Pages can be enabled in Automotive Mode. Two additional pages appear during active navigation while in Automotive Mode—a Current Route Page appears if you are navigating a turn-by-turn route, and an Active Route Page appears if you are navigating “Off Road.” See “[Navigating in Automotive Mode](#)” beginning on the next page for more information.



Map Page



Compass Page  
(Optional)



Highway Page  
(Optional)

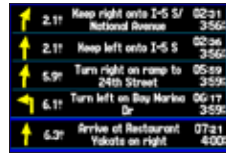

Current Route Page



Trip Computer Page



XM Audio Page  
(Optional)

To add the Compass, Highway, or XM Audio Pages:

1. Press **MENU** twice to show the Main Menu. Use the **ROCKER** to highlight the **Display** tab.
2. Highlight the **Highway Page**, **Compass Page**, or **XM Audio Page** fields, and press **ENTER**. Select **On**, and press **ENTER**.

## Navigating in Automotive Mode

Automotive Mode and Marine Mode are similar. Most of the features discussed here also apply to Marine Mode.

There are several ways to begin navigating to a point in Automotive Mode:

- Select a point on the map and press **Direct To**  $\rightarrow$  .
- Press **Direct To**  $\rightarrow$  to start a new route using the Find menu, or start a saved route or track.
- Press **NRST/FIND** to search for a particular item and create a route to it.

You can also start a saved route through the Routes tab on the Main Menu. For more information, refer to [page 61](#).

To go to a highlighted map item:

1. Use the **ROCKER** to highlight the item you would like to navigate to on the Map Page.
2. Press **Direct To**  $\rightarrow$ . **Go To <point name>** is added to the list of options and automatically highlighted. If you have selected an area of the map that is not a map feature, **Go To MAP Point** is listed. Select **Go To <point name>** or **Go To MAP Point**, and press **ENTER**.

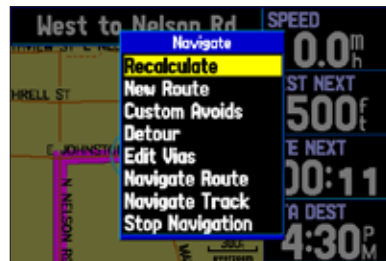

**Navigate Options in Automotive Mode**

*With Map Feature highlighted while navigating a course*

3. Follow the magenta route created on the Map Page. Follow the turn-by-turn route (auto-route) by using the Next Turns Page and Current Route Page. If you are using the external speaker, follow the voice prompts.



**To start new route using the Find Menu:**

1. Press **Direct To**  $\blacktriangleright$  to open the Navigate menu.
2. Highlight **New Route** (or **Go To Point** when in Marine Mode), and press **ENTER** to open the Find Menu.
3. From the Find Menu, highlight **Waypoints**, and press **ENTER**. (You can also choose to go to other points, such as **Cities** or **Services** from this list. The steps vary only slightly from those listed for **Waypoints**.)
4. Select a waypoint from the list, and then press **ENTER** to show the Waypoint Page.

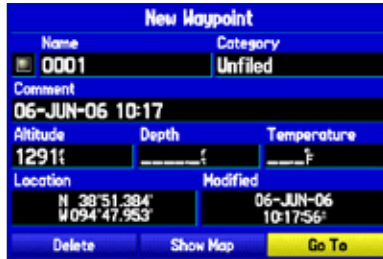
**Waypoint Page**

*Activating a Go To using the Find Menu*

5. The Waypoint Page automatically opens. With the **Go To** button highlighted, press **ENTER** to begin navigation.

**To search for an item and route to it:**

1. Press **NRST/FIND** to open the Find Menu.
2. Using the **ROCKER**, highlight a category, such as **Cities**, and press **ENTER**.
3. Press **ENTER** and use the **ROCKER** to begin entering the letters contained in the item name. The list begins to sort by the items that contain the letters you are entering. Press **ENTER**.

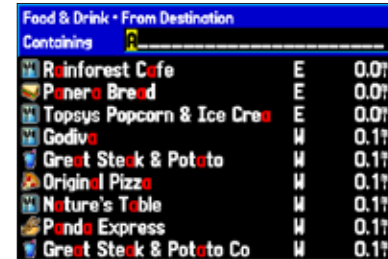

*Finding an item using the Containing field: The unit searches for items containing the letter combination you enter and shows them in the list.*

4. Highlight an item from the list, and press **ENTER**.
5. Highlight the **Go To** button, and press **ENTER**.

For complete information about finding an item, refer to [page 58](#).

## Finding an Item

The Find Menu allows you to easily search the stored waypoints and points of interest. Press **NRST/FIND** to access the Find Menu.

The Find Menu is comprised of several default categories such as Waypoints, Cities, Exits, Addresses, Crossroads, Food & Drink, Attractions Aviation Points, Transportation, and Weather Data.



Find Menu

Follow the directions on the previous page to search for an item near your current location and then route to it.

## Using the Find From Feature

The Find option also supports a “find from” feature that allows you to center your search around an item that you have just found.

### To find an item from another location on the map:

1. Open the Map Page. Use the **ROCKER** to pan the arrow (pointer) to the location you want, and press **NRST/FIND**.



Find From Map Pointer

2. The Find Menu opens showing “From Map Pointer.” The list of items is sorted to show items nearest the selected location. Using the **ROCKER**, highlight the category you want from the list, and press **ENTER**.
3. Using the **ROCKER**, highlight an item from the list, and press **ENTER**. The item’s information page automatically opens, allowing you to save the item as a waypoint, show the item on the map, or automatically create a route to (Go To) the item.

**To find an item from another location:**

1. From any page, press **NRST/FIND**.
2. Using the **ROCKER**, highlight the category you want from the list, and press **ENTER**.
3. Press **MENU**. Highlight **Near Other**, and press **ENTER**. If you are actively following a route, you can also choose one of the other options listed in the Find From list, as shown below.

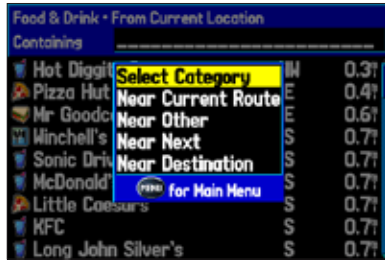
**Find From Options**

4. Select a reference location on the map, and press **ENTER**. The list shows items near the new map location.

**To find an item near another item:**

1. Press **NRST/FIND**.
2. From the Find Menu, highlight the item you want to Find From.
3. Press **NRST/FIND** with the item highlighted. The Find Menu opens again with items near the previously selected item. Search for the item.

**Recently Found Items**

The Recently Found Page shows a list of the items you have searched for or gone to recently.

**To view recently found items:**

1. Press **NRST/FIND**. The Find Menu opens.
2. Use the **ROCKER** to highlight **Recently Found**. Press **ENTER**. The Recently Found Page opens.
3. Press **MENU** to show the options menu:

**Show Find History**—allows you to toggle between showing the items you have searched for recently (Find History) and the items you have recently created a Go To for (Go To History).

**Remove Point**—removes the point that is highlighted in the list.

## Viewing the Information Page

Each item on the map and each item listed in the Find Menu results list has an information page.

### To view details about an item:

1. Highlight a point on the map or in the search results list, and press **ENTER**.

An Information Page appears with details about the item in a tabbed format. Based on the type of item, additional options are available for viewing the item on the map, viewing the list of maps on your data card, and viewing the next item in the search results list.



Information Page

2. Press **PAGE** or **QUIT** to exit the information page. You can also highlight one of the on-screen buttons, and press **ENTER** to perform that operation.

## Find Menu Options

To view additional options for the Find Menu, press **NRST/FIND**, and then press **MENU**.

**Enable Auto Arrange**—automatically arranges the Find Menu.

**Disable Auto Arrange** and **Restore Default** options appear when you select **Enable Auto Arrange**.

**Near Other**—allows you to select a new location from which to compile the Find items list. Using the **ROCKER**, move the map arrow to a location, and press **ENTER**.

**Map Information**—shows information about the detailed map data stored on the data card and allows you to select which maps are shown on the Map Page.

Additional selections are included in the options menu when you are navigating:

**Near Next**—compiles the Find items lists based on the next turn in the route.

**Near Destination**—compiles the Find items lists based on the route destination.

**Near Current Route**—compiles the Find items lists based on the active route.

## Creating Routes

The GPSMAP 496 lets you create and store up to 50 reversible routes, with up to 300 waypoints each.

Routes can be created in two ways. The first way is to select waypoints from the Find Menu, allowing you to see a list of the route points as you create the route. The second way is by selecting waypoints or map items from the Map Page, allowing you to see each route point graphically on-screen as you create the route.



Route Tab

### To create a route using the Find Menu:

1. Press **MENU** twice to show the Main Menu.
2. Use the **ROCKER** to highlight **Route** from the vertical list of tabs.
3. Press **MENU** to show the Route options menu. Select **New Route**, and press **ENTER**.  
OR  
Highlight the first available blank route slot and press **ENTER**. The Route Review Page automatically opens, showing a blank route.
4. Press **ENTER** to find items to add to the route.
5. The Find Page or Find Menu opens (based on which Usage Mode you are in). Using the methods discussed in the “[Finding an Item](#)” section beginning on [page 58](#), select a point to add to your route. When you find an item, highlight **OK**, and press **ENTER** to add the point to the route. Repeat until you have added all of the points to the route.

Waypoint	Course	Distance	ETA
ALEXANDE	093h	0f	12:16h
SMUDGE	---	2.8h	12:17h
<b>Total</b>	<b>093h</b>	<b>2.8h</b>	<b>12:17h</b>

Creating a New Route on Route Review Page

**To create a route graphically:**

1. Press **MENU** twice to show the Main Menu. Use the **ROCKER** to highlight **Route** from the vertical list of tabs.
2. Press **MENU** to show the Route options menu. Select **New Route**, and press **ENTER**.
3. Highlight the first blank slot in the Route List Page, and press **MENU**. Use the **ROCKER** to highlight **Edit on Map**, and press **ENTER**.
4. Use the **ROCKER** to highlight the location, and press **ENTER**. Press **MENU** and select **Append To Route**.

If you select an area of the map that is not a feature or waypoint, a new waypoint is created for that location. Press **ENTER** on the New Waypoint Page to save the location as a waypoint and continue adding points to your route. You can edit the properties of this waypoint as you can with any waypoint.



Creating a New Route on the Map

5. Repeat until you have added all points to the route.
6. When finished, press **QUIT** twice to return to the Route Review Page.  
OR  
Press **MENU**, highlight **Edit as Text**, and press **ENTER** to view the Route Review Page.

**To follow a saved route in Automotive Mode:**

1. Press **MENU** twice to show the Main Menu. Use the **ROCKER** to highlight **Route** from the vertical list of tabs.
2. Highlight the route you want to start, and press **MENU**.
3. Highlight **Activate Route**, and press **ENTER**.
4. The Active Route Page opens. Press **MENU**. Highlight **Follow Roads**, and press **ENTER**. The GPSMAP 496 automatically generates a turn-by-turn route following roads.

If you want to follow roads on your route, press **MENU** and select **Follow Roads** on the Active Route Page.

## Creating Waypoints

Waypoints are locations or landmarks you record and store in your GPSMAP 496. Save your current location as a waypoint by pressing and holding **ENTER/MARK**. You can also find waypoints using the map or Find Menu and then store them in the unit.

The GPSMAP 496 stores up to 3,000 alphanumeric waypoints with a user-defined icon, category, comment, altitude, depth, and temperature available for each waypoint. Waypoints can be created using three basic methods:

- **ENTER/MARK**—allows you to quickly mark your present location.
- **Graphically**—allows you to define a new waypoint location from the map show using the **ROCKER**.
- **Text Entry**—allows you to enter a new waypoint's location coordinates manually.

## Marking Your Present Location

The **ENTER/MARK** key lets you quickly capture your present location to create a new waypoint. You must have a valid location (2D or 3D) fix to mark your present location. You can determine the satellite fix by looking at the **GPS** tab on the Main Menu.

### To mark your present location:

1. Press and hold **ENTER/MARK** until the New Waypoint Page appears, then release it. A default four-digit name and symbol are assigned for the new waypoint.

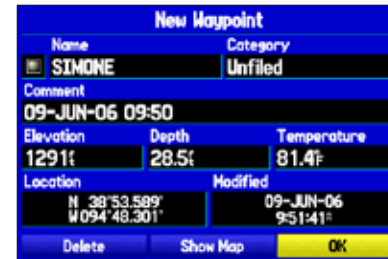

New Waypoint Page

2. To accept the waypoint with the default information, use the **ROCKER** to highlight **OK**, and press **ENTER**.
3. To change any information on the New Waypoint Page, highlight the appropriate field, and press **ENTER**. After entering and confirming your changes, highlight **OK**, and press **ENTER**.

## Creating Waypoints From the Map

You can create a waypoint using the Map Page. When you pan the map and move the arrow over a map item, a highlighted description of that item appears. The GPSMAP 496 uses the map item text shown on the map as the default name and symbol for the new waypoint.

### To create a new waypoint using the Map Page:

1. Press **PAGE** until the Map Page appears.
2. Use the **ROCKER** to move the arrow to the map location, or map feature.
3. Press and quickly release **ENTER/MARK** to capture the arrow location. Pressing and holding **ENTER/MARK**, marks your present location, not the arrow's location.

If you have highlighted a map feature, an information page appears after you press **ENTER**. Use the **ROCKER** to highlight **Save**, and press **ENTER** to save the item as a waypoint. The New Map Waypoint Page appears.



### Map Feature Information Page

Select **Save** to save the map feature as a waypoint

4. To accept the waypoint with the default information, highlight **OK**, and press **ENTER**.

To change any information on the New Map Waypoint Page, highlight the appropriate field, and press **ENTER**. After entering your changes, highlight **OK**, and press **ENTER**.



## Creating a Waypoint by Entering Coordinates

You can manually enter location coordinates to create a waypoint. This method is useful for creating a waypoint at a specific latitude/longitude location from a chart. You can manually change the location coordinates in the New Waypoint Page to create a new waypoint or use the **Create Waypoint** selection in the User Points tab options menu.

### To create a new waypoint by entering location coordinates:

1. Press **ENTER/MARK** to create a waypoint (or use your favorite method discussed in previous sections). The new waypoint is created with the next available waypoint number and the receiver's last known location as the default location.



*To change the location of a waypoint, highlight the character you want to change in the **Location** field. Press up or down on the **ROCKER** to change the character. Repeat until the new location is entered.*

2. On the New Waypoint Page, use the **ROCKER** to highlight the **Location** field, and press **ENTER**. Use the **ROCKER** to enter the location coordinates, and press **ENTER** when finished.
3. To change any of the other information, highlight the appropriate field, and press **ENTER**. Use the **ROCKER** to enter the new information.
4. After entering your changes, highlight **OK**, and press **ENTER**.

## Following an Automotive Route

The GPSMAP 496 guides you to your destination using many tools, such as the Map Page and Current Route Page.

### Track Your Progress with the Map Page

You can track the progress of your route on the Map Page. Your route is shown with a magenta line. The next turn appears in the top bar on the Map Page.



Map Page Displaying Your Route

### Watch your Trip Data

Use the Trip Computer Page to view your trip data. You can track your speed here, as well as other information related to your trip.

## Current Route Page in Automotive Mode

Whenever you have started a turn-by-turn route in the GPSMAP 496 set in Automotive Mode, the Current Route Page shows each turn of the active route, with the distance to the turn, the street name, estimated time to arrival, and time of arrival. As you navigate a route, the next turn appears at the top of the list.

↑	2.1 <sup>m</sup>	Keep right onto I-5 S/ National Avenue	02:31 3:56 <sup>R</sup>
↑	2.1 <sup>m</sup>	Keep left onto I-5 S	02:36 3:56 <sup>R</sup>
↑	5.9 <sup>m</sup>	Turn right on ramp to 24th Street	05:59 3:59 <sup>R</sup>
↙	6.1 <sup>m</sup>	Turn left on Bay Marina Dr	06:17 3:59 <sup>R</sup>
↑	6.3 <sup>m</sup>	Arrive at Restaurant Yakata on right	07:21 4:00 <sup>R</sup>

Current Route Page

## Starting and Stopping Navigation

Press **Direct To** ➔ to open the Navigate menu. Highlight **Stop/Resume Navigation**.

## Editing Your Route

When you are navigating a route, you can edit that route. You can add areas and roads to avoid as well as temporary detours to your current route. You can also add stops along your trip, called Via Points.

While navigating, press **Direct To**  to open the Navigate Menu, shown below.

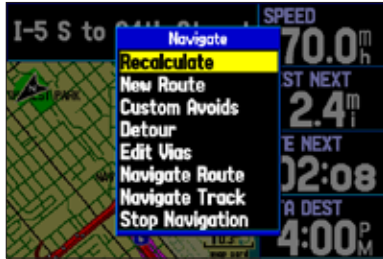

**Navigate Options in Automotive Mode**

*While navigating a course*

## Entering Custom Avoids

**Custom Avoids** allow you to enter specific areas and roads that you would like to avoid in your navigation. **Custom Avoids** apply to all routes, but **Detours** apply to only the active route. Custom Avoids can be added while you are navigating a route or before you navigate.

### To enter a custom avoid:

1. Press **Direct To**  while in Automotive Mode.  
OR  
Open the Map Page, and press **MENU**.
2. Select **Custom Avoid**. Press **ENTER**.
3. Press **ENTER** when the **Add Avoid** button is highlighted.
4. Select **Avoid Road** or **Avoid Area**, and press **ENTER**.
5. Use the **ROCKER** to move the arrow to the first point in the avoidance area. Press **ENTER** to select the first point.
6. Move the arrow to the end point and press **ENTER**. During route calculation and navigation, the GPSMAP 496 avoids the area within the box or the selected area of the road.
7. When finished, highlight the **OK** button, and press **ENTER**.

## Creating a Detour

If, while navigating a route, there is road construction or a closed road, you can have your GPSMAP 496 create a detour route. While navigating a course, press **Direct To**  $\rightarrow$ . Select **Detour** from the Navigate menu. Select the distance you want, and press **ENTER**. The GPSMAP 496 recalculates your course based on your detour distance. To end the detour manually, press **Direct To**  $\rightarrow$  again and select **Cancel Detour**.

## Adding and Editing Stops (Via Points)

You can add Via Points—points through which you would like to travel—to your route using the **Edit Vias** option. Via points are great for adding a stop at the gas station or bank to your route and are really helpful when planning a long trip.

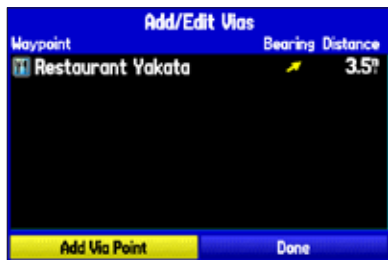

**Add/Edit Vias Page**

*Showing the original route without via points*

### To add Via Points to your route:

1. While navigating your route, press **Direct To**  $\rightarrow$  to open the Navigate menu.
2. Use the **ROCKER** to select **Edit Vias**, and press **ENTER**.
3. The Add/Edit Vias window opens. Press enter with **Add Via Point** highlighted.
4. From the window, highlight either **Use Map** or **Find** and press **ENTER**.
5. If you selected **Use Map**, use the **ROCKER** to select an item on the map and press **ENTER**.  
If you selected **Find**, select an item from the Find Menu as discussed in the “[Finding an Item](#)” beginning on [page 58](#). Remember you can press **MENU** while the Find Menu is open to find an item near another location, such as your destination.
6. The new point is added to the route and appears in the Add/Edit Vias Page. Continue steps 2 through 4 until you have added all of the Via Points that you want. Highlight **Done**, and press **ENTER** to apply the new Via Points to the route.

## Automotive Mode Pages and Features

This section discusses the major pages in Automotive Mode, such as the Map Page, as well as some additional features, such as routes and points.

### Map Page

Refer to [pages 29–36](#) in the “[Aviation Mode Pages](#)” section for more details about the Map Page.

The location marker (icon) that shows your travel on the Map Page is a triangle symbol ▲ in Marine and Automotive modes. The GPSMAP 496 always turns on in location mode, with the last known location centered on the map. When you press the **ROCKER**, the GPSMAP 496 enters pan mode, which moves the map to keep the white arrow (map pointer) within the screen area.

In Automotive Mode, by default, four user-selectable data fields appear on the right side of the screen that can be configured to show any one of the possible data options. The top of the screen shows the GPS status or the route leg. You can also add additional data fields to the page or select a full screen map without data fields.

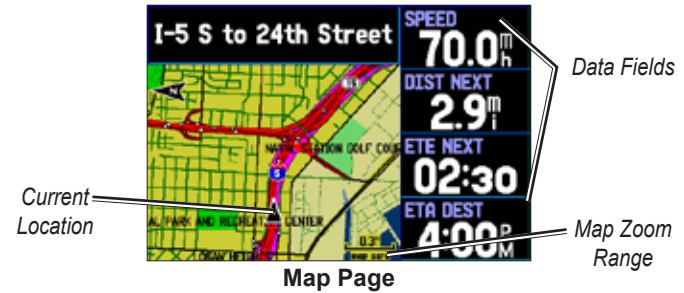

Press the zoom keys (**IN** and **OUT**) to change the map range. Some items on the map appear only if the map is zoomed in to a certain level.

Press **MENU** to open the options menu for the Map Page.

Enter **Custom Avoids** so your routes does not include areas you would like to avoid, such as high traffic areas.

Use the **ROCKER** to measure the distance between two objects on the map.

Change the page layout and data fields to customize the Map Page.

## Highway Page

The Highway Page is only available in Marine Mode and Automotive Mode. In Automotive Mode, the Highway Page is not shown by default. See the directions to the right to show the Highway Page.



Highway Page

When you are navigating, the Highway Page provides digital and graphic steering guidance to the destination. The right side of the Highway Page features user-selectable data fields showing useful navigation information. A compass ribbon appears at the top of the page to show your current heading as the violet bar and a red vertical bar indicates the bearing to your course.

### To hide/show the Highway Page:

1. Press **MENU** twice to show the Main Menu.
2. Use the **ROCKER** to highlight the **Display** tab.
3. Highlight the **Highway Page** field, and press **ENTER**.
4. Select **Off** to hide or **On** to show, and press **ENTER**.

### Using the Highway Page

To stay on course, steer toward the violet bar (or arrows) until it lines up with the red bar in the middle. The bottom section of the screen provides visual guidance to the waypoint on a graphic highway. The line down the center of the highway represents your track line.

As you head toward your destination, the highway perspective moves to indicate your progress to the waypoint and which direction you should steer to stay on course. If you are navigating a route, the Highway Page shows each route waypoint in sequence connected by a black “road” with a white line down the middle, which is your track line. Nearby waypoints not in the active route can also be shown. You can zoom in or out to show a larger or smaller view of the highway.

### To change the highway perspective scale:

- Press **IN** to zoom in.
- Press **OUT** to zoom out.

## Highway Page Options

The Highway Page options menu allows you to define the data fields and select which waypoints and track are shown on the screen. The data fields, located along the right side of the page, provide a user-selectable layout of various types of useful data. The layout can also be changed to show additional data fields.

### To show and select the Highway Page Options:

1. Press **PAGE** repeatedly until the Highway Page appears.
2. Press **MENU**.
3. Use the **ROCKER** to highlight the option.
4. Press **ENTER**.



Highway Page Options Menu

The following options are available from the Highway Page menu:

**Set up Page Layout**—allows you to choose the number of data fields.

**Change Data Fields**—allows you to specify the type of data shown in each data field used on the map screen. This option is available from any of the main pages. See [page 174](#) for a listing of the data fields.

**Set Up Highway**—shows an options menu with two tabs: Line, and Waypoint. Each tab has On/Off settings for several options, such as enabling the line for the Active Leg and Track Log.



Set up Highway

## Current Route Page

Whenever you have started a route in the GPSMAP 496 in Automotive Mode, the Current Route Page shows each turn of the active route, with the distance to the turn, the street name, and estimated time enroute and time of arrival. As you navigate a route, the turn list automatically updates to indicate the next turn at the top of the list.

↑	2.1 <sup>m</sup>	Keep right onto I-5 S/ National Avenue	02:31 3:56 <sup>PM</sup>
↑	2.1 <sup>m</sup>	Keep left onto I-5 S	02:36 3:56 <sup>PM</sup>
↑	5.9 <sup>m</sup>	Turn right on ramp to 24th Street	05:59 3:59 <sup>PM</sup>
↙	6.1 <sup>m</sup>	Turn left on Bay Marina Dr	06:17 3:59 <sup>PM</sup>
↑	6.3 <sup>m</sup>	Arrive at Restaurant Yakata on right	07:21 4:00 <sup>PM</sup>

Current Route Page

You can scroll through the entire list by pressing the **ROCKER** up or down. Highlight any of the turns on the list and press **ENTER** to view the Next Turn Page for that turn. The Current Route and Next Turn Page screen show similar information, just in a different layout. The Next Turn Page shows your next turn on a map.



Next Turn Page

## Saving the Current Route

You can save the current route from the Current Route Page. Press **MENU** to save the route. Press **ENTER** when **Save Route** is highlighted. Your route is automatically saved, using the starting point and destination as the route name. Highlight **OK** and press **ENTER** to complete saving the route.



## Trip Computer

The Trip Computer Page provides a quick reference for the important data you want to show in Automotive Mode. It indicates your current speed and many helpful statistics about your trip, such as bearing, average speed, and moving time.

You can reset the Trip Computer before beginning a trip. If you make frequent stops, leave the GPSMAP 496 turned on to allow the unit to accurately measure elapsed time during the trip.

Trip Computer		
<b>NE</b> 3:55:39 <sup>h</sup>	<b>54.0</b> <sup>m/h</sup>	<b>0.1</b> <sup>m</sup> 00000.1 <sup>h</sup>
Moving Average	Total Average	Maximum Speed
<b>2.5</b> <sup>m</sup>	<b>0.0</b> <sup>m</sup>	<b>2.9</b> <sup>m</sup>
Moving Time	Stopped Time	Total Time
<b>00:01:19</b>	<b>02:49:27</b>	<b>02:50:46</b>

Trip Computer Page

### Trip Computer Page Options

Press **MENU** while on the Trip Computer to show the options menu. The following options are available from the Trip Computer Page. Some options are only available if you have changed the page layout from the default.

**Set Up Page Layout**—allows you to choose the layout and number of data fields. You can also select a graphical **Dashboard**, select to show the Position Data Page layout (**2 Columns**), or select **4 Big Fields** as the layout of the page. You can change the Data Fields on the **2 Columns** and **4 Big Fields** layout pages.

**Change Nearest Type**—allows you to specify the type of item to be used as the nearest item (shown in the lower-left data field of the Position Data (**2 Columns**) layout). The choices differ based on the Usage Mode you are currently using.

**Reset Trip**—clears trip information, except the maximum speed and the odometer.

**Reset Max Speed**—clears the maximum speed.

**Reset Odometer**—clears the running total of the distance traveled.

**Reset All**—clears all trip information including the maximum speed and odometer.

## Editing and Managing Routes

The Route tab shows the routes you have created in your GPSMAP 496 unit. For complete information on routes, see [pages 61–62](#).

### Viewing All of Your Saved Routes

The Route tab in the Main Menu lists all of your saved routes and routes on one easy-to-read route list.



Route Tab

#### To view the route list:

1. Press **MENU** twice to open the Main Menu.
2. Highlight **Route** from the vertical menu of tabs using the **ROCKER**.

## Using the Route Options

The Route tab in the Main Menu shows all the routes currently stored in memory, along with a descriptive name for each route. Highlight a route, and press **MENU** to open the options menu. From here you can start a route, copy it, delete it, delete all routes, and create a new route. You can also set up the routes to manually transition to the next waypoint.

### Manually Transitioning to the Next Waypoint

From the Route tab Option Menu, highlight **Set up Routes**, and press **ENTER** to set the route leg transition (or waypoint transition). Select **Distance** to enter a radius so that when you are within the entered distance, the GPSMAP 496 leads you to the next point on your route.

When you select **Manual**, you can transition to the next waypoint while navigating a route. While you are navigating the route, open the Active Route Page. Press **MENU**. Highlight **Next Route Waypoint**, and press **ENTER** to have the GPSMAP 496 start routing you to the next point in your route.

## Navigating a Saved Route

The Navigate Route option allows you to easily select a saved route. For information about creating routes, see [pages 61–62](#).

### To navigate a route in Automotive Mode:

1. In Automotive Mode, press **Direct To**  $\rightarrow$ .
2. Use **ROCKER** to highlight **Navigate Route**, and press **ENTER**.
3. Highlight a route, and press **ENTER**. The Active Route Page automatically opens with the route started.



Select Route

4. Press **MENU** to open the options menu.
5. Highlight **Follow Roads**, and press **ENTER** to create a turn-by-turn route (auto-route), which appears in the Current Route Page.

## Editing a Route

After you create a route, use the Route Review Page to edit, change the name, and review route points for a selected route.

### To change the name of the route:

1. Press **MENU** twice, and highlight **Route**.
2. From the Route List Page, use the **ROCKER** to highlight the name of the route, and press **ENTER**.
3. From the Route Review Page, use the **ROCKER** to highlight the route name field at the top of the page, and press **ENTER**.



Route Review Page

4. Use the **ROCKER** to enter the route name and then press **ENTER**.

**To review individual route points:**

1. Press **MENU** twice, and highlight **Route**.
2. Use the **ROCKER** to highlight the name of the route, and press **ENTER**.
3. From the Route Review Page, highlight the point, and press **ENTER**.

Route			
ALEX-LOTS OF FISH			
Waypoint	Course	Distance	ETA
ALEX	S	0	4:57
LOTS OF FISH	—	21.1	5:06
<b>Total</b>			
	S	21.1	5:06

Route Review Page

4. On the point review page, choose **Next** (highlight the next point on the route list), **Show Map** (show the point on a map window), or **Save** (save the point as a waypoint), and press **ENTER**. If the route point is a user waypoint, you can edit any of the waypoint properties on the Waypoint Page (see the [“Editing and Managing Waypoints”](#) section beginning on [page 78](#)).

When you return to the Route Review Page, the next point in the route is automatically highlighted. This allows you to review each point on the route by pressing **ENTER** repeatedly.

**To add points to the route:**

1. Press **MENU** twice to open the Main Menu. Use the **ROCKER** to select **Route**.
2. Use the **ROCKER** to select the route, and press **ENTER**.
3. Use the **ROCKER** to highlight the spot in the route that you want to add the new point. (The new point is added before the highlighted route point.) Press **MENU**.
4. Highlight **Insert Waypoint**, and press **ENTER**. The Find Menu automatically opens for you to search for and select the point you want to add to the route.
5. In the point review page, highlight **OK**, and press **ENTER** to add the new point to the route.

**To edit the route on the map:**

1. Press **MENU** twice to open the Main Menu. Use the **ROCKER** to select **Route** from the vertical menu of tabs.
2. Select the route, and press **ENTER**. Press **MENU** to open the Route Review Page options menu.
3. Highlight **Edit on Map**, and press **ENTER**.
4. Use the **ROCKER** to select a location on the route (the route turns white when the arrow is over the route). Press **ENTER**.
5. Use the **ROCKER** to drag the route to the new point location, and press **ENTER**.

*Editing the route on the map*

6. If the New Waypoint Page opens, edit the waypoint, highlight **OK**, and press **ENTER**.
7. Repeat steps 4 through 6 until all points are added to the route. Press **QUIT** to finish.

**To set speed and fuel/plan your route:**

1. Open the Route Review Page options menu.
2. Highlight **Plan Route**, and press **ENTER**. (Highlight **Set Speed and Fuel** in Aviation Mode.)

*Entering Speed and Fuel Flow for trip planning*

3. Enter the data for Speed and Fuel Flow. When in Marine and Automotive Modes, you also can enter the date and time of your departure. Press **QUIT** to return to the Route Review Page.



**NOTE:** Fuel flow rates are measured in “units per hour”. System setting changes for units of measure (statute, nautical or metric) do not affect the fuel flow measure. You should enter fuel flow rates based on information for your vehicle (such as the operator’s manual or performance specifications) and note the units of measure (gallons or liters).

## Editing and Managing Waypoints

When you have created and stored a waypoint, you can modify, review, rename, move, or delete it at any time through the Waypoint Review and Waypoint Edit Pages. These pages provide virtually the same information. For practical purposes, we refer to these pages as the “Waypoint Pages,” unless it is necessary to discuss them individually.

### To access the Waypoint Review Page from the Map:

1. Use the **ROCKER** to highlight the waypoint on the Map Page.
2. Press **ENTER** to show the Waypoint Review Page. If the waypoint is located on a map feature or MapSource or BlueChart feature, the Waypoint Review Page can include additional tabs containing information about the other features at that location.



Waypoint Review Page

### To access the Waypoint Edit Page:

1. Press **MENU** twice to open the Main Menu.
2. Use **ROCKER** to highlight **Points** from the vertical list of tabs, and highlight the waypoint from the list.



Points Tab in the Main Menu

3. Press **ENTER** to show the Waypoint Edit Page.

If the waypoint is located on a map feature or MapSource or BlueChart feature, the Waypoint Edit Page does NOT show the details of the other map features.

Use either of these methods to access the Waypoint Page so you can edit and manage the waypoint.

**To change the waypoint name:**

1. Open the Waypoint Review or Waypoint Edit Page.
2. Highlight the **Name** field, and press **ENTER**.
3. Use the **ROCKER** to enter a new name, and press **ENTER** when finished.

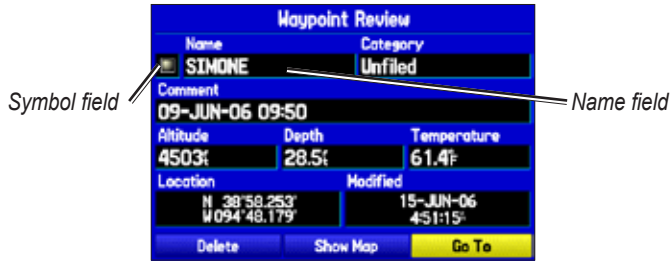
**Waypoint Review Page****To change the waypoint symbol or other element:**

1. Open the Waypoint Review or Waypoint Edit Page.
2. Highlight the waypoint symbol field to the left of the waypoint name or highlight another field you want to change, and press **ENTER**.
3. Use the **ROCKER** to select the symbol or enter data, and press **ENTER**.

**To view the waypoint on the map:**

1. From the Waypoint Page, highlight **Show Map**.
2. Press **ENTER**. The waypoint is highlighted on a map with an information window at the top that shows the waypoint name, location and distance and bearing from your current location.

On the Show Map screen, two additional options are available by pressing **MENU**:

**Measure Distance**—allows you to measure the distance and bearing between two points on the map (see [page 33](#) for more information).

**Point to on Main Map**—returns to the highlighted waypoint on the Map Page and exits the Waypoint Page.

## Adding a Waypoint to a Route

**Append to Route** adds the selected waypoint to the end of a route. This option appears when you are not navigating. When you are navigating to a destination, **Add to Current Route** appears. The selected waypoint is added to the current route before the route destination.

### To add a waypoint to the end of the route:

1. Open the Waypoint Page, and press **MENU** to open the options menu.

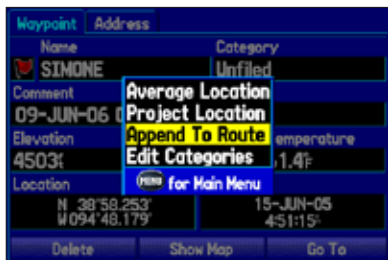

Waypoint Options Menu

2. Select **Append To Route** from the options menu. The Select Route window appears.
3. Highlight the route or select **New Route**, and press **ENTER**.
4. With **OK** highlighted, press **ENTER** to save the waypoint.

## Averaging the Waypoint's Location

**Average Location** makes the unit take several sample location measurements for the waypoint and recalculate for a more accurate location reading.

### To calculate the average location:

1. Open the Waypoint Page, and press **MENU** to open the options menu.
2. Select **Average Location** from the menu, and press **ENTER**. The Average Location window appears.



Average Location

3. Watch the fields change as the unit calculates the average location of the waypoint. Press **ENTER** to save the location.



**NOTE:** You must have a GPS satellite fix before you can average a waypoint's location.



## Projecting a Waypoint

You can also create a new waypoint by “projecting” the distance and bearing from a specific location to a new location.

### To create a new waypoint by projecting its location:

1. Create a waypoint using your favorite method (discussed in previous sections). The new waypoint is created with the next available waypoint number and the receiver’s last known location as the default location.
2. Press **MENU** twice to open the Main Menu.
3. Highlight **Points** from the vertical list of tabs using the **ROCKER**.
4. Press **MENU** to open the New Waypoint Page options menu.
5. Highlight **Project Location**, and press **ENTER**.

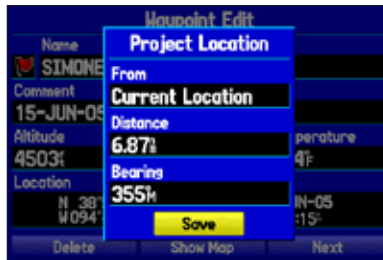

### Project Location Menu

*Enter the distance, bearing, and location to project from.*

6. To change the location from which you are projecting the new waypoint, highlight the **From** field, and press **ENTER**. The Find Menu opens.

Select the point from which you project your new waypoint just as you would select a waypoint or point of interest. For more information see the “[Finding an Item](#)” section beginning on [page 58](#).

7. To adjust the distance that the new waypoint is projected beyond the original waypoint, highlight the **Distance** field and press **ENTER**. Enter the projection distance and press **ENTER**.

To adjust the bearing that the new waypoint is projected from the original waypoint, highlight the **Bearing** field and press **ENTER**. Enter the bearing, and press **ENTER**.

8. When you have adjusted all elements of the projected location, highlight **Save**, and press **ENTER**.
9. Make any other changes to the new waypoint data (such as the name or symbol), highlight **OK**, and press **ENTER**.

## Organizing Waypoints into Categories

You can organize your waypoints into categories, which can help when managing and using your waypoints. For example, you can create a “Vacation” category that stores all of the waypoints you use for your upcoming vacation. When the vacation is over, you can delete all the waypoints in that category by pushing a few buttons. You can create up to 15 categories.

### To create a waypoint category:

1. From any of the waypoint pages or the **Points** tab, press **MENU** to open the options menu.
2. Select **Edit Categories**, and press **ENTER**.



3. Use the **ROCKER** to highlight **Add**, and press **ENTER**.



4. Use the **ROCKER** to enter a name for the category.
5. Highlight **Save**, and press **ENTER**.

Now, when you create or edit a waypoint, you can select the category from the Category list on the Waypoint Page.

### To delete a category:

1. With the Waypoint Categories window open, highlight the category to delete. Press **MENU**.
2. Select **Delete Category**, and press **ENTER**.

**To assign a category to a waypoint:**

1. Open the Waypoint Page. (You can also change the category on the New Waypoint Page.)
2. Select the **Category** field, and press **ENTER**.



Select the category to which you want to assign this waypoint.

**Waypoint Page**

3. Select the category you want, and press **ENTER**.

**Managing Points**

The Points tab features two sub tabs, User and Proximity, that let you edit waypoints and manage a large number of waypoints quickly and efficiently. For more information about creating, editing, and deleting waypoints, refer to the “[Creating Waypoints](#)” section beginning on [page 63](#).

**To access the Points tab of the Main Menu:**

1. Press **MENU** twice to open the Main Menu.
2. Highlight **Points** from the vertical list of tabs.

**User Points Tab**

The User Points tab shows a master list of all waypoints currently stored in memory. From the User list, you can review, edit, rename, or delete individual waypoints or delete all user waypoints.



**User Points Tab**

The total number of stored and available waypoint information is available at the bottom of the User sub tab, with the stored waypoints arranged in alphanumerical order.

### To start a Go To from the User Points tab:

1. Press **MENU** twice to open the Main Menu.
2. Highlight **Points** from the vertical list of tabs, then highlight **User** from the top row of tabs.
3. Use the **ROCKER** to highlight a waypoint.
4. Press **Direct To**  $\rightarrow$ . Highlight **Go To <Point Name>**, and press **ENTER**.

OR

Press **ENTER** when the waypoint is highlighted to review the waypoint on the Waypoint Page. See the previous pages for detailed information on reviewing and editing waypoints.

## Deleting Waypoints

You can delete waypoints from the waypoint list in the **Points** tab or from the Waypoint Pages. To delete a waypoint from the Waypoint Page, use the **ROCKER** to highlight the on-screen **Delete** button and press **ENTER**.



**NOTE:** When you delete a waypoint, you cannot recover it from the unit. Back up important waypoints to a computer using the USB cable and software, such as MapSource, or write the coordinates down by hand.

### To access the Points tab:

1. Press **MENU** twice to open the Main Menu.
2. Highlight **Points** from the vertical list of tabs.
3. Press the **ROCKER** right or left to highlight **User** or **Proximity** to open that sub tab.



### To delete a waypoint from the User sub tab:

1. From the **User** sub tab, use the **ROCKER** to highlight the waypoint you want to delete.
2. Press **MENU**, highlight **Delete Waypoint**, and press **ENTER**.
3. Press **ENTER** to confirm.

**To delete waypoints by symbol or category:**

1. From the **User** sub tab, highlight the waypoint you want to delete, and press **MENU**.
2. Highlight **Delete by Symbol** or **Delete by Category**, and press **ENTER**.
3. When deleting by symbol, highlight the symbol of the waypoint you want to delete, and press **ENTER**.

When deleting by category, select the category you want to delete from the list, and press **ENTER**.

4. Highlight **OK**, and press **ENTER** to confirm. Choose **Cancel** or press **QUIT** to exit without deleting.

**To delete waypoints by distance:**

1. From the **User** sub tab, highlight the waypoint to be deleted, and press **MENU**.
2. Highlight **Delete By Distance**, and press **ENTER**.
3. Select **Less Than** or **More Than**, and **ENTER** the distance using the **ROCKER**.
4. You can select a waypoint or point of interest as the **From** location. Highlight the **From** field, and press **ENTER**. From the Find Menu, select the location, and press **ENTER**. When **OK** is highlighted, press **ENTER**.
5. Highlight **Delete**, and press **ENTER** to delete all waypoints within the set location. Choose **Cancel** or press **QUIT** to stop the deletion.

**Proximity Points**

The Proximity Points tab lets you define an alarm circle around a stored waypoint location. The alarm circle can help you avoid reefs, rocks, or restricted areas. Up to 100 waypoints can be listed with a maximum alarm radius of 99.99 nautical miles, statute miles, or kilometers.



**Proximity Points Tab**

If a proximity alarm circle overlaps an existing alarm circle, a “Proximity Overlaps Another Proximity Waypoint” message appears. Because the unit only alerts for one of the overlap points, use caution when navigating in these areas. If you enter an alarm circle overlap, you are only alerted to the closest proximity waypoint.

**To turn proximity alarms on or off:**

1. Press **MENU** twice to open the Main Menu.
2. Highlight **Points** from the vertical list of tabs. Highlight **Proximity** from the row of tabs along the top of the screen.
3. Use the **ROCKER** to highlight the field below **Proximity Alarm**, and press **ENTER**.
4. Select the **ON** or **OFF** setting, and press **ENTER**.

**To add a proximity waypoint:**

1. From the Proximity Points tab, use the **ROCKER** to highlight an empty line on the Proximity List, and press **ENTER**. The Find Menu appears.
2. Select the waypoint or point of interest from the Find Menu. With **OK** highlighted, press **ENTER** to select that point. (For complete information about the Find Menu, see "[Finding an Item](#)" on [page 58](#).) The distance field is now highlighted.
3. Press **ENTER** to begin entry of the proximity radius.
4. Use the **ROCKER** to enter a distance value (up to 99.99 units), and press **ENTER**.

**To clear one or all proximity waypoints from the list:**

1. Open the **Proximity** sub tab.
2. Use the **ROCKER** to highlight the proximity waypoint to clear, and press **MENU**.

**Proximity Points Tab Options Menu**

3. To clear a single alarm, highlight **Remove Point**, and press **ENTER**. To clear all proximity waypoints, select **Remove All**, and press **ENTER**.
4. Use the **ROCKER** to highlight **OK**, and press **ENTER**.

## Managing Your Tracks

The GPSMAP 496 draws an electronic breadcrumb trail or “track log” on the Map Page as you travel. The track log contains points along its path, including time, and location for each point.

The track log starts recording as soon as the GPSMAP 496 gets a location fix. For the best results, clear the track log before you start traveling because when the track log is full, new track points overwrite the oldest track points.

The percentage of memory used by the current track log appears at the top of the Active sub tab. After the track log is cleared, it shows zero percent. When the screen reaches 100%, the most recent track points start to overwrite the least recent track points (if **Wrap** is selected for **Record Mode**). To avoid losing track points, save the track log when it approaches the 99% mark.

You must first save the track log before you can use the **Navigate Track** feature. The **Save** feature allows you to store up to 15 track logs from certain times and dates.

### To access the Track tab:

1. Press **Menu** twice to open the Main Menu.
2. Highlight **Track** from the vertical list of tabs.

## Setting Up and Saving Your Tracks



Active Track Tab

**Record Mode**—**Wrap** records over the oldest tracks when the track log reaches 100%. **Fill** records a track log until the track log is full (100%). When **Off** is selected, the unit does not record tracks.

**Interval**—**Distance** records track points after a specified distance has been traveled. **Time** creates track points after a specified time has elapsed. **Resolution** records track points based on the resolution. The higher the resolution entered, the more points the unit creates to make the track.

**Value**—records a track according to the **Interval** and **Value**. Enter a specific distance, time, or resolution.

**Color**—select a color for the track when it appears on the map.

**To clear the track log:**

1. Press **MENU** twice to show the Main Menu.
2. Highlight **Track**, then highlight the **Active** sub tab to the right.
3. Select the **Clear** button, and press **ENTER**.

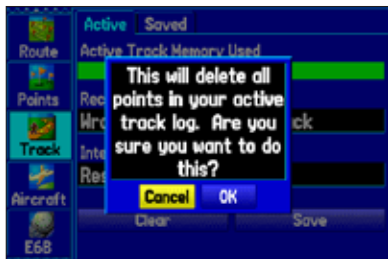

Clearing the Track Log

4. Highlight **OK**, and press **ENTER**. Press **QUIT** to exit.

**To save the entire track log:**

1. Press **MENU** twice to open the Main Menu.
2. Highlight **Track**, then highlight the **Active** sub tab to the right.
3. Use the **ROCKER** to select **Save**, and press **ENTER**.
4. A window pops up asking if you want to save the entire track log. To save the entire track, highlight **Yes**, and press **ENTER**.

**To save a portion of the track log:**

1. Press **MENU** twice to open the Main Menu.
2. Highlight the **Track** tab, and highlight the **Active** sub tab.
3. Use the **ROCKER** to select **Save**, and press **ENTER**.
4. To save only a portion of the track, highlight **No**, and press **ENTER** when the window appears.
5. Select a beginning point, and press **ENTER**. Select an ending point, and press **ENTER**. The Track Review Page automatically opens.



Saving a Portion of the Track Log

6. Highlight **OK**, and press **ENTER** to save the track. Press **QUIT** to exit.



## Saved Sub Tab

The Saved sub tab lists all of the saved tracks in your unit.

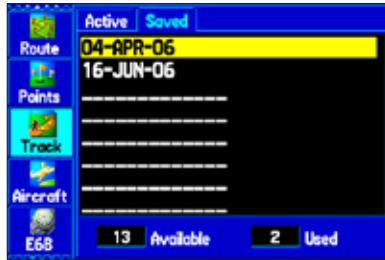

Saved Sub Tab

Press **MENU** to open the Saved sub tab options menu:

**Review on Map**—shows the highlighted track on the Map Page.

**TracBack**—navigates the track. You can either navigate the track as it is saved, or you can navigate the track in reverse.

**Delete Track**—erases highlighted track from the unit's memory.

**Delete All**—erases all tracks from the unit's memory.

### To edit a track:

1. Press **MENU** twice to open the Main Menu.
2. Highlight the **Track** tab. Press the **ROCKER** right to highlight the **Saved** sub tab.

3. Highlight the track you want to edit, and press **ENTER**. The Track Review Page opens. Make changes you want.

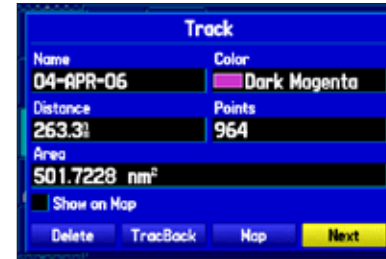

Track Review Page

4. Highlight the **Name** field, and press **ENTER**. Use the **ROCKER** to change the name, and press **ENTER**.
5. Select a different screen color when the track appears on the map.
6. To show this track on the map, highlight the box next to **Show on Map**, and press **ENTER**.
7. To begin a TracBack, highlight **TracBack**, and press **ENTER**. For more information about the TracBack feature, refer to the next page.
8. To view the track on the map, highlight **Map**, and press **ENTER**. Press **QUIT** to return to the **Track** tab.
9. Highlight **OK**, and press **ENTER** to save the track. Press **QUIT** to exit.

## Navigating a Saved Track

The TracBack function allows you to retrace your path using the track log automatically stored in the receiver's memory, which eliminates the need to store waypoints along the way. TracBack routes are created by reducing your track log into a route with up to 300 turns and activating an inverted route along those points. When activated, a TracBack route leads you back to the oldest stored track log point, so it is a good idea to clear the existing track log before you start your current trip. You must save an active track log before you can navigate it as a TracBack.

### To start a TracBack using Direct To key:

1. Press **Direct To** , then highlight **Navigate Track**, and press **ENTER**.



Selecting a Saved Track

2. Highlight the saved track you want to navigate, and press **ENTER**.
3. Use the **ROCKER** to select the point you want to navigate to (TracBack to), and press **ENTER**.

## TracBack Tips

When a TracBack has been started, the GPSMAP 496 divides the track into segments called legs. Up to 300 temporary turns are created to mark the most significant features of the track in order to duplicate your exact path as closely as possible. To get the most out of the TracBack feature, remember these tips:

- Always clear the track log at the point that you want to go back to (such as a dock or campsite).
- The **Record Mode** option on the Active Track tab must be set to **Fill** or **Wrap**.
- If the track log **Interval** option on the **Active** tab is set to the **Time** option, the route may not navigate your exact path (keep the interval set to Resolution for best performance).
- If the receiver is turned off or satellite coverage is lost during your trip, the TracBack draws a straight line between any point where coverage was lost and where it resumed.
- If the changes in distance and direction of your track are too complex, 300 waypoints may not mark your path accurately. The receiver then uses the most significant points of your track so there are fewer changes in direction.

## Basic Operation in Marine Mode

To switch usage modes:

1. Press and hold the **PAGE/MODE** button.
2. Use the **ROCKER** to select either **Aviation**, **Automotive**, or **Marine**, and press **ENTER**.

### Marine Mode Page Sequence

Marine Mode features five main pages: the Map, Compass, Highway, Active Route, and Position Data Page, as well as an optional XM Audio Page. If you are connected to a sonar module, such as a Garmin GSD 20 or GSD 21, an additional Sonar Page is available.



Map Page



Compass Page



Highway Page



Active Route Page



Position Data Page



XM Audio Page  
(Optional)

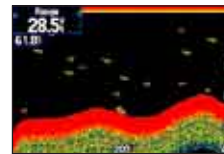

Sonar Page  
(Optional)

## Navigating in Marine Mode

Press **Direct To**  $\rightarrow$  on any page to begin navigating to a destination. The **Go To Point**, **Navigate Route**, and **Navigate Track** options operate the same as in Automotive Mode. Refer to the previous section for detailed instructions on those options. In Marine Mode, you can initiate Man OverBoard (MOB) navigation, which places a waypoint in the location and then navigates you back to that location.



**Navigate Options in Marine Mode**

*Accessed by pressing **Direct To**  $\rightarrow$*

When you are actively navigating, a magenta line always runs from your current location to the destination on the Map Page. You can use the Map Page, Compass Page, Highway Page, and Position Data Page to help navigate to your destination.

## Man OverBoard (MOB)

The Man OverBoard function (MOB) lets you simultaneously mark and set a course to a location for quick response to emergency situations.

### To start the MOB function:

1. In Marine Mode, press and hold **Direct To**  $\rightarrow$  or press **Direct To**  $\rightarrow$  twice.



*Man OverBoard confirmation screen*

2. Press **ENTER** to confirm and begin navigating to the MOB location.



When an MOB has been started, an MOB waypoint with an international MOB symbol is created and the unit begins actively navigating to that point. Use any of the navigation Pages to guide you back to the MOB point. The MOB waypoint is stored in the waypoint list and can be deleted like any other waypoint.

## Marine Mode Pages and Features

Marine Mode operates in a similar fashion to Aviation Mode, while also providing many features and operations of Automotive Mode. Refer to the corresponding sections in the Aviation and Automotive sections for further details.

### Map Page

Refer to [pages 29–36](#) in the “[Aviation Mode Pages](#)” section for more details about the Map Page.

The location marker (icon) that shows your travel on the Map Page is a triangle symbol  in Marine and Automotive modes. The GPSMAP 496 always turns on in location mode, with the last known location centered on the map. When you press the **ROCKER**, the GPSMAP 496 enters pan mode, which moves the map to keep the white arrow  (map pointer) within the screen area.

In Marine Mode, by default, five user-selectable data fields appear on the right side of the screen that can be configured to show any one of the possible data options. You can also add additional data fields to the page or select a full screen map without data fields.

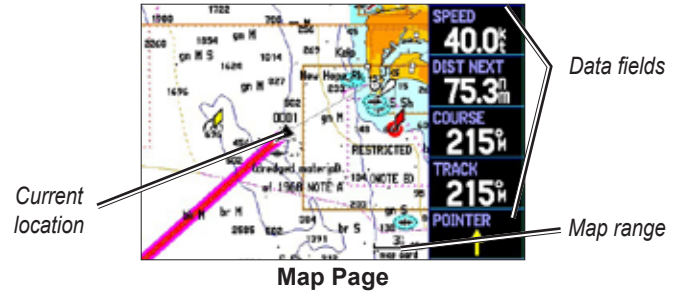

Press the zoom keys (**IN** and **OUT**) to change the map range. Some items on the map only appear if the map is zoomed in to a specified level.

- Press **ENTER** to quickly declutter (remove unwanted items) from the Map Page.
- Press **MENU** to open the options menu for the Map Page.
- Show and hide the heading line from the options menu.
- Use the **ROCKER** to measure the distance between two objects on the map.
- Change the page layout and data fields to customize the Map Page.

## Compass Page

During active navigation, the Compass Page guides you to your destination with data fields and a graphic compass screen with a bearing pointer.



The middle of the page features a rotating compass ring that shows your course over ground (track) while you are moving. Your present course over ground is indicated at the top of the compass ring. The direction of the destination (bearing) relative to the course over ground is indicated by an arrow in the middle of the compass ring and a course to steer “bug” on the outside of the compass ring.

The compass ring and bearing indicators work independently to show the direction of your movement and the direction to your destination. If the arrow points up, you are going directly to the

waypoint. If the arrow points any direction other than up, turn toward the arrow until it points up, then continue in that direction.



**NOTE:** You must be moving for the compass to accurately update and show your heading.

The right side of the Compass Page shows user-selectable data fields that show additional information during active navigation. For definitions of data field settings, refer to [page 174](#).

### Compass Page Options

The options menu on the Compass Page allows you to customize the Compass Page. Like the Map Page, the Compass Page features user-selectable data fields on the right side of the screen. When the Compass Page is open, press **MENU** to open the options menu.

**Show Course Pointer/Show Compass**—toggles between showing the Course Pointer, which shows how far off you are from your course and how to get back on course, or showing the compass arrow. The Course Pointer is also referred to as a CDI or Course Deviation Indicator.

**Show/Hide Bug Indicator**—toggles between showing and hiding the course to steer bug indicator (the purple tick mark on the compass ring).

## Using the Marine Timer

The Marine Timer, specifically designed for sail boat racing, allows you to easily count up or down specified time increments. As common in sail boat racing, there is often a 5 minute warning countdown, followed by a 4 minute preparation countdown, and finally a one minute final countdown. You must change the Compass Page layout to use the Marine Timer.

### To open the Marine Timer:

1. Press **PAGE** repeatedly until the Compass Page appears.
2. Press **MENU**.
3. Use the **ROCKER** to highlight **Set up Page Layout**, and press **ENTER**.
4. Highlight **2 Columns With Timer**, and press **ENTER**. The Marine Timer appears in the lower right corner.

### To use the Marine Timer:

1. Press the **ROCKER** up or down to select the time you want to count. Five (5) minutes is the default.
2. Press **ENTER** to start the timer. Use the **ROCKER** during the timing to quickly select a different length of time.
3. Press **ENTER** to stop timing.



Marine Timer on the Compass Page

As discussed previously, the timer is set to count down five minutes. If you want to change the length of time and the behavior or the timer, open the Timers Setup tab in the Main Menu.

### To set the Marine Timer:

1. Press **MENU** twice to open the Main Menu.
2. Press the **ROCKER** down to select **Setup** and then right to select the **Timers** sub tab.
3. Highlight **Stop** next to **Marine**, and press **ENTER** to change the timer's behavior. Highlight the behavior you want, and press **ENTER**.
4. Highlight the time field, press **ENTER**, and then use the **ROCKER** to enter a new time. The maximum time is 60:00 (minutes: seconds). Press **ENTER** when finished.

## DSC

The DSC Page allows you to control and set up the Digital Selective Calling (DSC) features on the GPSMAP 496.

DSC uses marine VHF radio and GPS technologies to transmit and receive location information. The chartplotter repeats the call properties received from the VHF radio on the chartplotter. The GPSMAP 496 requires input from a DSC enabled VHF radio to show position, and to sound/show alerts from a distress call or position report. Conversely, the VHF radio requires input from a GPS to transmit position coordinates for a distress call or position report. For connection information, refer to “[Connecting the Power and Data Cable](#)” on [page 158](#).

An emergency DSC distress call allows a vessel in trouble to transmit a substantial amount of information in a single transmission or call, without the need for voice communication. When any nearby rescuer receives the DSC signal, an alarm sounds and they immediately receive the location of the caller. The rescuer can then choose to navigate to the caller’s location to assist, or forward the call on to the Coast Guard. When the Coast Guard receives the call, they can immediately access the caller’s information (such as who they are and the type of vessel) in their database while they are in transit to the caller’s location.

A non-emergency DSC Position Report allows mariners to exchange and show the positions of one another. When a DSC position is received, the mariner can choose to create a waypoint or to show the received location on an electronic map.

Anytime a vessel receives a DSC call, they can store and quickly navigate to that location using a Go To. This makes DSC a time saver, especially in an emergency situation. In order to use DSC, users must first register their VHF radio with the FCC and receive a Maritime Mobile Service Identity (MMSI) number.

For more information about Digital Selective Calling and Maritime Mobile Service Identity (MMSI) numbers, refer to [page 168](#).

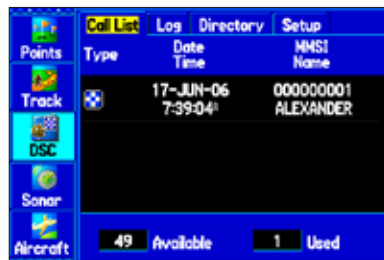

DSC Page



## Understanding Distress Calls

When the GPSMAP 496 receives a distress call from a connected DSC enabled VHF radio, an alert message and notification page appear, and an alarm tone is sounded. Distress calls are shown in the DSC Call List, and Log with a checkered symbol.

You also have the ability to input a caller's name, if it is known. The caller's name replaces the MMSI number as a reference when entered.

## Understanding Position Reports

A position report is similar to a distress call except no alarm is sounded. Position reports are not broadcast to all DSC users and are shown with a boat symbol.

## Receiving DSC Calls

Each time you receive a distress call or position report, a Notification page appears, and the call is placed in the DSC Call List and Log. The Notification page contains information about the call including: the type of call (distress or position report), the MMSI number of the caller, a user definable name, the time and date of the call, the bearing and distance from your current position, and

the coordinates of the caller. To see the caller's location on a map, select the **Show Map** button. To create a waypoint at the caller's location, select the **Create Wpt** button. To close the Notification page, press the **QUIT** key.

When a Distress Call or Position Report is placed in the Call List and Log, the information on the Notification page is retained. To review a DSC call or log entry, highlight the entry and press **ENTER**. The DSC Entry Review page is identical to the Notification page with one exception, the entry can be deleted.

### To review a call or log entry:

1. Open the Call List or Log from the **DSC** tab
2. Press up or down on the **ROCKER** to highlight the call you want to review.
3. Press **ENTER** to open the DSC Entry Review Page.

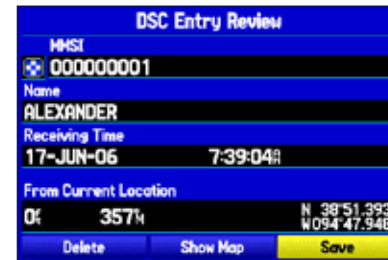

DSC Entry Review Page

## DSC Call List

The DSC Call List shows the 50 most recent calls, even if the unit is left unattended. The Call List shows the most recent call from a vessel. If a second call is received from the same vessel, it replaces the first call in the Call List. Press **MENU** to sort the list and delete entries.

Points	Type	Date Time	MMSI Name
Track	Track	17-JUN-06 7:39:04	000000001 ALEXANDER

49 Available 1 Used

DSC Call List

## DSC Log

When DSC calls are received, they are automatically stored in the Log, with the latest call at the top. The unit can store up to 100 logs. When 100 logs are received, the oldest log file is removed when a new call is received. Press **MENU** to sort the list and delete entries.

Points	Type	Date Time	MMSI Name
Track	Track	17-JUN-06 7:48:12	000000001 ALEXANDER
DSC	DSC	17-JUN-06 7:47:10	000000001 ALEXANDER
Sonar	Sonar	17-JUN-06 7:39:04	000000001 ALEXANDER

97 Available 3 Used

DSC Log

## DSC Directory

The DSC Directory acts much like a phone book and can hold up to 50 entries. Pressing **MENU** from this page allows you to add a **New Item**, **Delete** a highlighted entry, or **Delete All** entries.



When a distress call, position report or directory item is named, the name is attached to that particular MMSI number. If a name is used, all DSC entries of the same MMSI number show the name.

Another way to input a name is from the Entry Review Page or the DSC Distress Call or DSC Position Report Pages. The Name and MMSI are sent to other Garmin GPS units: Only the MMSI numbers are sent to other non-Garmin DSC users.

### To add a new Directory entry:

1. Open the DSC Directory in the Main Menu.
2. Use the **ROCKER** to highlight the first blank space in the directory list, and press **ENTER**.  
OR  
Press **MENU**, highlight **New Item**, and press **ENTER**.
3. Enter the MMSI number, the name, and any comments.
4. When finished, highlight **OK**, and press **ENTER**.

## Navigating to a Position Report or Distress Call

After a Position Report or a Distress Call is received, navigation can be quickly set to the call location.

### To navigate to a Position Report or Distress Call using the Direct To $\rightarrow$ key:

1. Press **Direct To  $\rightarrow$** .
2. With **Go To** (MMSI/Name) highlighted, press **ENTER**.

### To navigate to a Position Report or Distress Call using the Call List or Log:

1. Highlight the call on the **Call List** or **Log**, and press **Direct To  $\rightarrow$** .
2. With **Go To** (MMSI/Name) or (DSC) highlighted, press **ENTER**.

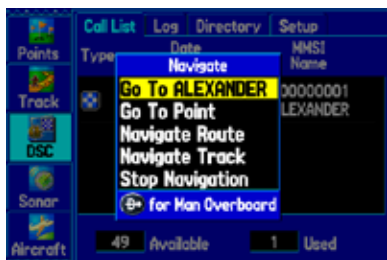

Navigating to a DSC Call

## Setting up DSC

The DSC Setup tab allows you to turn DSC on and off. This Setup tab also allows you to simulate distress calls and position reports while the unit is in Simulator Mode (see [page 11](#)). Simulating calls is helpful for practice before connecting to the real system. The distress call simulator also helps to check if alarms are working properly.

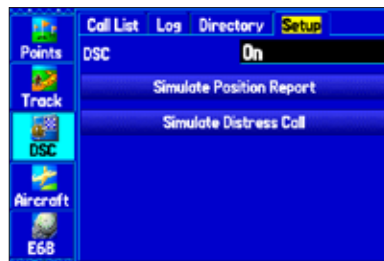

DSC Setup

## Main Menu

The Main Menu features some additional pages that are useful to you as you plan trips and use your GPSMAP 496. Some of these pages have already been discussed in-depth in previous sections. This section only contains the additional pages and features found in the Main Menu that have not been discussed yet.

The following tabs in the Main Menu can be restored their defaults: Track, E6B, Alarms, Display, Sound, and Setup.

### To restore defaults:

1. Press **MENU** twice to open the Main Menu.
2. Use the **ROCKER** to highlight a tab.
3. Press **Menu** to open the options menu.
4. Highlight **Restore Default**.
5. Press **ENTER** to restore the tab to the defaults.

To restore all of unit's settings to the factory defaults at once, select **All Unit Defaults** from the options menu of the Setup tab.

## GPS Tab

The GPS tab provides a visual reference of satellite acquisition, receiver status, and accuracy. The sky view and signal strength bars give an indication of what satellites are visible to the receiver and whether they are being tracked. More information on the GPS tab is located on [page 4](#).

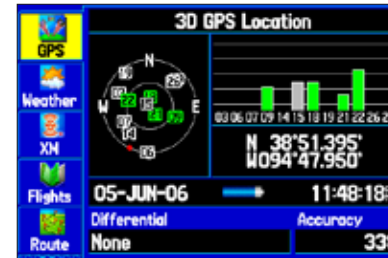

GPS Page

## Weather Tab

Use the Weather tab to view individual weather features without turning all other weather features on or off. For example, you can select Storm Cells to view only storm cell data on the Map window that appears on the Weather tab. When you close the Main Menu and return to the Map Page, all of your previously selected weather features still appear on the Map Page. Information on the Weather tab is located on [pages 126–131](#).



**NOTE:** You must have a subscription to XM WX Weather and the GXM 30A antenna must be plugged in to the USB port on the back of the unit to use features described in this section. For more information about subscribing to XM WX Weather, see [page 180](#).



Map Page with XM WX Weather

## XM Tab

The XM tab is where you can view and select XM Radio channels, add or delete favorites, and obtain radio ID and XM WX Satellite Weather service level information. The XM tab is divided into two sub tabs: Audio and Information. Information on the XM tab is located on [pages 51–54](#).



**NOTE:** The XM tab always appears on the Main Menu, regardless of whether the XM Audio Page is turned on or off. For more information about the XM Audio Page, see [page 114](#).

## Audio Sub Tab

The Audio sub tab shows XM Radio channel categories, a list of available channels, information about the selected channel, and the strength of the XM signal.



XM Tab Audio Sub Tab

## Information Sub Tab

Use the Information sub tab to view the radio identification number, XM WX Satellite Weather subscription information, and a list of weather features available to you based on your subscription plan. The Information sub tab also shows the age of each weather report in minutes.



XM Tab Information Sub Tab

## Flights Tab

The Flights tab shows a list of any recorded flights, including date, route of flight, and flight time. The GPSMAP 496 saves up to 50 recorded flights while in Aviation Mode. Entries on this list are automatically created for each flight. More information on the Flights tab is located on [page 46](#).



Flight Tab

*Showing the flight details page*

## Route Tab

Use the Route tab create and store up to 50 reversible routes, with up to 300 points each. See the “[Creating Routes](#)” section beginning on [page 61](#) for more information about routes.

## Points Tab

The Points tab contains two sub tabs, **User** and **Proximity**, which allow you to manage a large number of waypoints quickly and efficiently. For more information about waypoints, see the “[Creating Waypoints](#)” section beginning on [page 63](#).

### User Sub Tab

The User sub tab shows a master list of all waypoints currently stored in memory. The total number of stored and available waypoints appears at the bottom of the User sub tab.

### Proximity Sub Tab

Use the Proximity sub tab to shows an alarm circle around a stored waypoint location.

## Track Tab

Use the Track tab to specify whether or not to record a track log, define how it is recorded, or save the track log data for future use. The Track tab is divided into two sub tabs: Active and Saved. For more information about tracks, see the “[Managing Your Tracks](#)” section beginning on [page 87](#).

### Active Sub Tab

The Active sub tab is for the active log (the log currently being recorded). It displays the amount of track memory used and current settings.

### Saved Sub Tab

The Saved sub tab displays a list of all saved tracks in your unit.



## Sonar Tab

The Sonar tab contains options for the Sonar Page. See the “[Setting Up the Sonar Page](#)” section beginning on [page 140](#) for more information about Sonar setup options.

### To access the Sonar Tab:

1. Press **MENU** twice to open the Main Menu.
2. Use the **ROCKER** to highlight the **Sonar** tab.

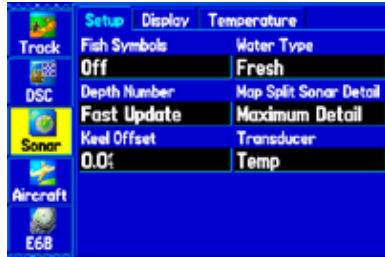

**Sonar Tab**

## Aircraft Tab

The Aircraft tab is divided into two sub tabs: Aircraft Profile and Weight & Balance. See [page 47](#).



**Aircraft Profile Tab**

## E6B Tab

The E6B tab in the Main Menu calculates Density Altitude, True Airspeed, and Winds Aloft (Head Wind, Tail Wind, Wind From, and Wind Speed), based on information you enter. See [page 49](#).

## Alarms Tab

The Alarms tab allows you to define alarm settings.

### To set an alarm:

1. Press **MENU** twice to open the Main Menu.
2. Use the **ROCKER** to select the **Alarms** tab.
3. Highlight the field below the alarm name you want activate, and press **ENTER**.
4. Change the mode to **On**, and press **ENTER**. If necessary, highlight the next field to the right, and press **ENTER**, enter the settings, and press **ENTER**.

When an alarm goes off, the alarm message appears on the screen and the unit emits five (5) beeps. When you select an alarm to be persistent, the alarm message appears on the screen and the unit beeps until you press **ENTER** to acknowledge the alarm.

### To set a persistent alarm:

1. Press **MENU** twice to open the Main Menu.
2. Use the **ROCKER** to select the **Alarms** tab.
3. Highlight the box next to the alarm you would like to make persistent (for example, **Next Turn**).
4. Press **ENTER** to place a check mark in the **Persist** box.  
When an alarm goes off, it sounds until you acknowledge the alarm message by pressing **ENTER**.

**Airspace Alarms Sub Tab (Aviation Mode Only)**  
**Class B, CTA; Class C, TMA; Towers, Cntrl Zones; Restricted, ADIZ; MOAs; Mode C Veils; Other SUAs**—enables and disables the alarms. Select **On** to enable or **Off** to disable.

**Altitude Buffer**—sets the buffer for the altitude alarm. Highlight the **Altitude Buffer** field, and press **ENTER** to select a different value. Use the **ROCKER** to select the digits.

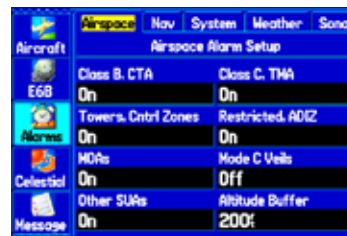

Airspace Alarms Tab

## Navigation (Nav) Alarms Sub Tab

**Next Turn**—sets an alarm to indicate next turn in route. Select **Off** for no Next Turn alarm. Select **Dist** to enter a specific distance. For example, if you enter 1 nm, the Next Turn alarm sounds one nautical mile before you reach the next turn. Select **Time** to enter a specific time before the turn for the alarm to go off. For example, if you enter 00:02:00, the Next Turn alarm sounds two minutes before you reach the next turn. Select **Auto** for the unit to provide a Next Turn

alarm at its discretion.

**Arrival**—sets an alarm to sound when you are a specified distance or time away from a destination waypoint. Select **Off** for no Arrival alarm. Select **Dist** to enter a specific distance. Select **Time** to enter a specific time before the destination for the alarm to go off. Select **Auto** for the unit to provide an Arrival alarm at its discretion.

**Off Course**—sets an alarm to sound when off your course. Select **On**, then enter a distance.

**Anchor Drag**—sets an alarm to sound when you have exceeded a specified drift distance. Select **On**, and then enter a distance.

**Custom POI**—sets an alarm to sound when you have entered the proximity of a custom POI.





---

**CAUTION:** Garmin is not responsible for the consequences of using a custom POI database or the accuracy of the safety camera or other custom POI database.

---

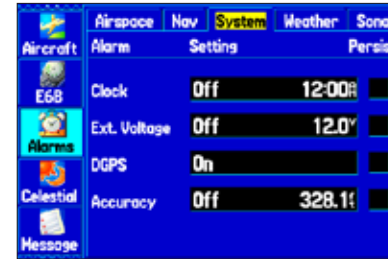
## System Alarms Sub Tab



System Alarms Sub Tab

**Clock**—sets an alarm based on the unit's clock. Select **On**, and then enter a specific time that you want the alarm to sound. The unit must be on for the clock alarm to work.

**Ext. (External) Voltage**—sets an alarm to sound when the external voltage drops below a specified amount. Select **On**, and then enter a specific voltage.

**DGPS**—sets an alarm to sound when the unit loses a differential fix.

**Accuracy**—sets an alarm to sound when GPS accuracy falls outside of the user-set value. Select **On**, and then enter a specific distance.

## Weather Alarms Sub Tab

You must be receiving XM WX weather information for the weather alarms to work.



Weather Alarms Sub Tab

**Tornado Warnings**—sets an alarm to sound when you enter an area where a tornado warning is in effect.

**Thunderstorm Warnings**—sets an alarm to sound when you enter an area where a severe thunderstorm warning is in effect.

**Flood Warnings**—sets an alarm to sound when you enter an area where a flood warning is in effect.

**Flash Flood Warnings**—sets an alarm to sound when you enter an area where a flash flood warning is in effect.

**Marine Warnings**—sets an alarm to sound when you enter an area where a marine warning is in effect.

## Sonar Alarms Sub Tab (Marine Mode Only)

You must be receiving sonar NMEA data for Sonar alarms to work.

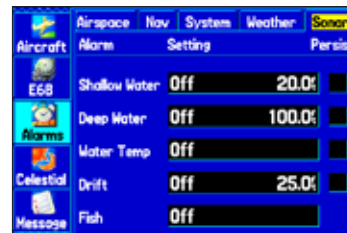

Sonar Alarms Sub Tab

**Shallow Water** and **Deep Water**—sets an alarm to sound when you enter an area of water that is too shallow or deep.

**Water Temp**—sets an alarm to indicate if the water temperature has exceeded or dropped below a specific temperature, or fallen outside/inside a specific temperature range. Select **Above** or **Below** and then enter a specific temperature, or select **Inside** or **Outside** and enter a range of temperatures.

**Drift**—sets an alarm to sound when you have exceeded a specified drift distance. Select **On**, and then enter a specific distance.

**Fish**—sets alarm to sound when unit detects a fish of the specified symbol size.

## Celestial Tab

The Celestial tab on the Main Menu shows sun and moon information, tide data, and hunting and fishing information. You can show this data for your current location, a location from the map, or a waypoint location. Also, you can select a different date and time, or use the current data.

### To access the Celestial Tabs of the Main Menu:

1. Press **MENU** twice to open the Main Menu.
2. Highlight **Celestial** from the vertical list of tabs.
3. Use the **ROCKER** to show the tab, such as **Sun & Moon**.

## Sun & Moon Sub Tab

The Sun & Moon sub tab provides you with sun rise/set and moon rise/set times. A graphic screen of the moon phase is also shown. You can view Sun & Moon information for any date or location. You can also use the play, fast forward, and stop buttons to view an animation of the Sun & Moon sub tab.

### To view Sun & Moon information for a different date:

1. Use the **ROCKER** to highlight the **Date** field and press **ENTER**.
2. Use the **ROCKER** to change the digits of the date to the date you want. You can also use the **Zoom IN** and **OUT** keys to view information for another date. Press and hold **IN** or **OUT** to scroll quickly through dates.
3. Press **ENTER** when finished. The unit shows the sun and moon information for the date you entered or selected.

To use the current date again, highlight the Date field. Press **MENU**, highlight **Use Current Date**, and press **ENTER**.

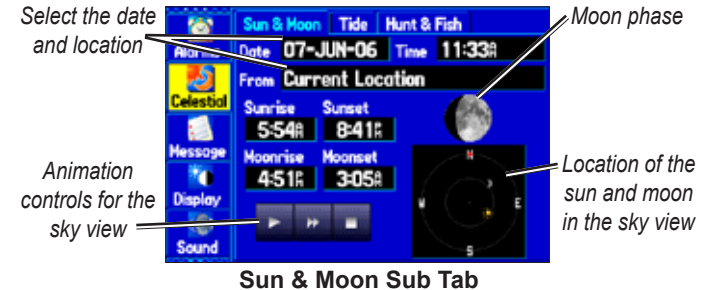

**To view Sun & Moon information for a different location:**

1. Use the **ROCKER** to highlight the **From** field and, press **ENTER**.
2. Highlight **Use Find Menu**, and press **ENTER**. The Find Menu automatically opens.
3. Select a waypoint or point of interest, and press **ENTER**.
4. On the waypoint information page, press **ENTER**. The unit shows the sun and moon information for the location you selected.

To use the current location, highlight the **From** field. Press **ENTER**, highlight Current Location, and press **ENTER**.

**Tide Sub Tab**

The Tide sub tab contains a graphical chart that shows tide station information in a 24-hour span starting at midnight station time. You can choose from different dates and more than 3,000 tide stations.

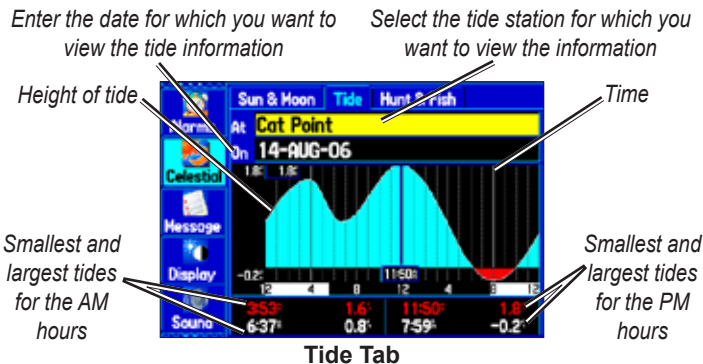

The top of the page shows the tide station and date being referenced. The chart shows a 24-hour block of time, with the time progressing from left to right. The solid vertical lines represent 4 hour increments; the dotted vertical lines represent 1 hour increments.

The tide curve shows as a shaded area, with higher tides being taller and lower tides shorter. The bottom of the page indicates the times with the largest and smallest tides.

**To view a tide chart for a different tide station:**

1. From the **Tide** tab, highlight the **At** field, and press **ENTER**. The Find Menu opens showing the tide stations.
2. Press **MENU** and select **Near Current Location, Near Current Route, Near Other** (select another location using the map), or **Near Destination**. The list is updated with your search requirements.
3. Select a tide station from the list, and press **ENTER**. The Tide Station Information Page opens.
4. Highlight **OK**, and press **ENTER**. The **Tide** tab appears again showing the tide chart for the selected tide station.

**To view the tide chart for another date:**

1. From the **Tide** sub tab with the chart shown, highlight the **On** field, and press **ENTER**.
2. Enter the date with the **ROCKER**, and press **ENTER**. You can also use the Zoom **IN** and **OUT** keys to view information for another date. Press and hold **IN** or **OUT** to scroll quickly through dates.
3. Press **ENTER**. The unit shows the chart for the date you entered or selected.

To use the current date again, highlight the **Date** field. Press **MENU**, highlight **Use Current Date**, and press **ENTER**.

**To view a chart's details for another time during the day (other than current time):**

1. From the **Tide** sub tab with the chart shown, press **MENU**, and select **Move Cursor**.
2. Press the **ROCKER** right or left to view the chart at another time.
3. To return to the current time, press **MENU**, and select **Stop Moving Cursor**.

**To automatically start pointer mode to scroll the chart:**

1. Use the **ROCKER** to highlight the **Date** field. Then press down to start the pointer (pan) mode.
2. Scroll the chart right to view the next day or left to view the previous day.

## Hunt & Fish Sub Tab

The Hunt & Fish sub tab provides you with predictions of the good and best times to hunt and fish in a selected location on a specific date.

### To show the Hunt & Fish information:

1. Press **MENU** twice to open the Main Menu.
2. Highlight **Celestial** from the vertical list of tabs using the **ROCKER**.
3. Use the **ROCKER** to select the **Hunt & Fish** sub tab.



Hunt & Fish Sub Tab

### To view Hunt & Fish information for a different date:

1. Highlight the **Date** field, and press **ENTER**.
2. Use the **ROCKER** to change the digits of the date to the date you want. You can also use the Zoom **IN** and **OUT** keys to view information for another date. Press and hold **IN** or **OUT** to scroll quickly through dates.
3. Press **ENTER** when finished. The unit shows the information for the date you entered.

To use the current date again, highlight the **Date** field. Press **MENU**, highlight **Use Current Date**, and press **ENTER**.

### To view Hunt & Fish information for a different location:

1. Use the **ROCKER** to highlight the **From** field, and press **ENTER**.
2. Highlight **Use Find Menu**, and press **ENTER**. The Find Menu automatically opens.
3. Select a point, and press **ENTER**.
4. On the information page, press **ENTER**. The unit shows the Hunt & Fish information for the selected location.

To use the current location, highlight the **From** field. Press **ENTER**, highlight **Current Location**, and press **ENTER**.



## Message Tab

The Message tab shows a list of messages generated by your GPSMAP 496. Use the **ROCKER** to scroll through the list of messages on the Log tab. Use the Log Filter tab to show only the types of messages you want to view.

### To view the messages:

1. Press **MENU** twice to open the Main Menu.
2. Highlight **Message** from the vertical list of tabs.

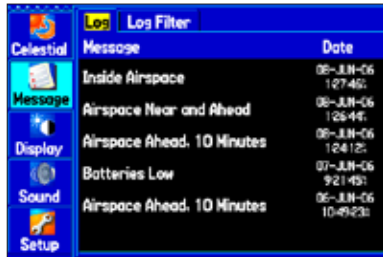

Message Log Tab

3. Use the **ROCKER** to highlight a message. Press **ENTER** to view detailed information about that message.

### To show or hide messages using the Log Filter:

1. Press **MENU** twice to open the Main Menu.
2. Highlight **Message** from the vertical list of tabs.
3. Use the **ROCKER** to highlight the **Log Filter** tab. By default all messages are shown.



Message Log Filter Tab

4. Use the **ROCKER** to highlight the message you want to hide, and press **ENTER**.
5. The message name then appears in the **Hide** window. Highlight the message, and press **ENTER** to show it again.

## Display Tab

The Display tab allows you to set several features the screen, such as what pages to show in the main page sequence and how long the backlight stays on.

### To view the Display tab:

1. Press **MENU** twice to open the Main Menu.
2. Highlight **Display** from the vertical list of tabs.

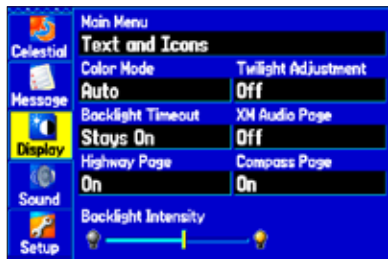

**Display Tab**

**Main Menu**—enables the main menu tabs to contain text and icons (default) or text tabs only.

**Color Mode**—sets the screen to a **Day**, **Night**, or **Auto** display. Auto switches from day to night at sunset and changes back at sunrise.

**Twilight Adjustment**—allows the unit to adjust the backlight for optimum viewing during twilight times.

**Backlight Timeout**—sets the backlight to stay on when it is turned on, or to time out after a selected period of time has elapsed when using the battery. The backlight stays on regardless of this setting when external power is used.

**XM Audio Page**—enables the page and places it in the main page sequence.

**Highway Page**—enables the page and places it in the main page sequence. Available in Marine and Automotive Modes only.

**Compass Page**—enables the page and places it in the main page sequence. Available in Marine and Automotive Modes only.

**Backlight Intensity**—turns the backlight up or down. Press the **ROCKER** right to increase the intensity or left to decrease.

### To restore the display to default settings:

1. Press **MENU** twice to open the Main Menu.
2. Highlight **Display** from the vertical list of tabs.
3. Press **MENU**.
4. Highlight **Restore Defaults**, and press **ENTER**.

## Sound Tab

The Sound tab allows you to customize the sounds your GPSMAP 496 makes to suit your needs.

### To view the Sound tab:

1. Press **MENU** twice to open the Main Menu.
2. Highlight **Sound** from the vertical list of tabs.



Sound Tab

**Beeper**—sets the beeper to chime during key presses and alarms (**Key and Alarm** or **Alarms Only**).

**Attention Tone**—turns the attention tone that sounds before the vocal prompts on and off.

**Voice Prompt**—sets the vocal prompt to operate for **Guidance and Status**, **Route Guidance Only**, or **No Voice Prompts**.

**Terrain Audio** (Aviation Mode)—turns audible terrain alerts on and off. Also enables or disables the audible “Five hundred” altitude reminder that occurs when you descend through 500 feet above the destination airport.

**TIS Audio** (Aviation Mode)—turns audible TIS traffic alerts on and off.

**Audio Volume**—sets the external speaker volume (when used). Press the **ROCKER** right to increase the volume or left to decrease.

**Audio Jack**—sets the type of audio signal generated from the unit's external audio jack. Use **Line Out** (default) to connect to your headsets or audio panel. Use **Headphones** for connecting directly to a pair of personal stereo headphones.

### To restore the sound to defaults:

1. Press **MENU** twice to open the Main Menu.
2. Highlight **Sound** from the vertical list of tabs.
3. Press **MENU**.
4. Highlight **Restore Defaults**, and press **ENTER**.

## Setup Tab

To customize how your GPSMAP 496 operates, adjust certain system settings in the Main Menu.

### System Sub Tab

To open the System tab, press **MENU** twice to open the Main Menu. Select **Setup** from the vertical tab list. Then select **System** from the row of tabs along the top of the page.



**System Setup Tab**

**System Mode**—sets the unit to operate in **Normal Mode**, **Battery Saver Mode**, or **Simulator Mode** (for practice ONLY).

**Usage Mode**—sets the unit to the mode you want.

**Speed Filter**—allows the unit to average speed readings. Choose from **Off**, **Auto** (automatically controls filtering), or **On** (allows you to enter a value in seconds).

**Text Language**—allows you to select from various languages for the unit's pages and menus.

**WAAS**—allows you to **Disable** and **Enable** WAAS from this field.

**External Power Off**—allows you to select whether the GPSMAP 496 remains on (**Stay On**) or the unit turns off (**Turn Off**) when external power is removed from the unit.

**External Power On**—allows you to turn the GPSMAP 496 on (**Turn On**) or charge the battery (**Charge Battery**) when external power is applied to the unit.

### VNAV Sub Tab

The VNAV sub tab on the Main Menu provides settings for the vertical navigation feature. These settings create a three-dimensional profile that guides you from your present location and altitude to a final (target) altitude at a specified location. See [page 42](#).



**VNAV Sub Tab**

## Road Routing Sub Tab

Use the Road Routing sub tab to select road routing settings.

### To access the Road Routing sub tab

1. Press **MENU** twice to open the Main Menu.
2. Use the **ROCKER** to select the **Setup** tab.
3. Press right on the **ROCKER** to select the **Road Routing** sub tab.



**Road Routing Sub Tab**

**Route Preference**—allows the unit to calculate a route for:

- **Faster Time**—routes calculated are faster to drive, but can be longer in distance.
- **Shorter Distance**—routes calculated are shorter in distance but can take more time to drive.
- **Off Road**—creates a direct line from your current location to your destination. This is useful when you are travelling outside of

detailed map coverage areas or where no roads exist.

**Ask My Preference**—determines whether you are asked to select a route preference before route calculations.

**Calculation Method**—sets how the unit searches for the route.

- **Quickest Calculation**—calculates the route the quickest, but it might not produce the best route.
- **Quick Calculation**—takes more time to calculate, but generates a better quality route.
- **Better Route**—generates an even better quality route, but uses a longer calculation time.
- **Best Route**—generates the most optimal route, but takes the longest time to calculate.

**Calculate Routes for**—sets route calculation for the particular vehicle you are operating to optimize the route for your vehicle type, some roads have vehicle-based restrictions.

**Avoid**—allows you to avoid certain road types and maneuvers on your route. The unit uses these road types only if alternative routes take you too far out of your way or if no other road is available.

**Custom Avoids**—allows you to enter specific areas and roads that you would like to avoid in your navigation. Refer to [page 67](#) for information on creating custom avoids.

**Custom Road Prefs**—allows you to avoid or use **Major**, **Medium**, and **Minor** roads using a slider scale. This is especially nice if you want to avoid major highways, for example.

## Guidance Sub Tab

To open the Guidance sub tab, press **MENU** twice to open the Main Menu. Select **Setup** from the vertical tab list. Then select **Guidance** from the row of tabs along the top of the page.



Guidance Sub Tab

**Off-Route Recalculation**—allows you to set whether the unit prompts you when it is recalculating your route (**Prompted**), or whether the unit recalculates automatically. You can also set whether the unit announces the recalculation (**Automatic - Announced**) or recalculates silently (**Automatic - Silent**). You can also turn route recalculation **Off**.

**Next Turn**—turns the Next Turn window **Off**, or opens the window when you hold **Direct To** **▶**, opens automatically (**Automatically Only**), or **Both**.

## Timers Sub Tab

To open the Timers sub tab, press **MENU** twice, select **Setup** from the vertical tab list, and **Timers** from the row of tabs along the top.



Timers Sub Tab

**User**—allows you to set the timer to **Count Up** or **Count Down**. You can also **Reset** the timer and turn it **Off**.

**Marine**—shows on the Compass Page in Marine Mode. See [page 94](#).

**Fuel Tank**—allows you to set a reminder for switching fuel tanks. The reminder message repeats at the specified interval after the beginning of each trip.

**Since Midnight**—allows you to view the time the unit has been turned on since midnight. This resets if you restore **All Unit Defaults** from the **System** tab.

## Time Sub Tab

The Time sub tab allows you to set the time format and time zone. You can also set the unit to conform to Daylight Saving Time. The current time and date is shown at the bottom of the page.

To open the Time sub tab, press **MENU** twice to open the Main Menu. Select **Setup** from the vertical tab list. Then select **Time** from the row of tabs along the top of the page.

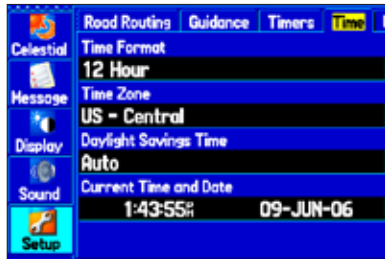

Time Sub Tab

**Time Zone**—allows you to choose your correct time zone so the GPSMAP 496 shows the correct local time. Select **Other** to enter a UTC Offset.

If the incorrect date is shown, press **MENU**, highlight **Set Date**, and press **ENTER**. Enter the current year. The GPSMAP 496 uses this information when gathering satellite data to show the correct date.

## Units Sub Tab

The Units sub tab allows you to customize measurement units for the entire system. To open the Units sub tab, press **MENU** twice to open the Main Menu. Select **Setup** from the vertical tab list. Then select **Units** from the row of tabs along the top of the page.

**Distance and Speed**—select the unit to show your speed and distance traveled.

**Direction Display**—select the unit to show your direction. Mils is a unit of angle measurement used in military settings, in which 17.78 mils equal one degree.

**Temperature**—select the unit to show the temperature.

**Altitude**—select the unit to show your altitude.

**Depth**—select the unit to show the depth.

**Vertical Speed**—select the unit to show your vertical speed.

**Pressure**—select the unit to show the pressure.

## Location Sub Tab

Refer to the “Appendix” of this guide for more information about location formats and map datums. Also visit the National Imagery and Mapping Agency at [www.nima.mil](http://www.nima.mil) for more information on grids and datums.

## Location Format Sub Tab

Changing the **Location Format** coordinates the system in which a given location reading is shown. The default format is latitude and longitude in degrees, minutes, and thousandths of a minute (hddd°mm.mmm).

## Map Datum Sub Tab

Datums are used to describe geographic locations for surveying, mapping, and navigation and are not actual maps built in the unit. The default setting is WGS 84. The unit automatically chooses the best datum based on your chosen position format.



---

**WARNING:** Selecting the wrong map datum can result in substantial location errors. You should only change the position format if you are using a map or chart that specifies a different position format or map datum or want to use a format you are familiar with. When in doubt, use the default WGS 84 datum for best overall performance.

---

## Selecting a Different Heading Reference

You can select from **Auto Mag Var**, **True**, **Grid**, and **User Mag Var**. **Auto Mag Var** provides magnetic north heading references that are automatically determined from your current location. **True** provides headings based on a true north reference. **Grid** provides headings based on a grid north reference (and is used in conjunction with the grid position formats).

**User Mag Var** allows you to specify the magnetic variation at your current location and provides magnetic north heading references based on the variation you enter. Enter the magnetic variation of your current location in the **Magnetic Variation** field if you have selected **User Mag Var** for the heading.



---

**WARNING:** If you select **User Mag Var**, the unit does not automatically calculate and update the magnetic variation at your present location. You must update the magnetic variation as your location changes. Failure to update this setting can result in substantial differences between the information shown on your unit and external references, such as a magnetic compass.

---



## Welcome Sub Tab

The Welcome sub tab allows you to enter information, such as your name and address, that the unit can show when it is turned on. This feature can be helpful if your unit is ever misplaced.

To open the Welcome sub tab, press **MENU** twice to open the Main Menu. Select **Setup** from the vertical tab list. Then select **Welcome** from the row of tabs along the top of the page.



Welcome Sub Tab

Enter the information in the fields. You do not need to enter information in every field.

To show this information at start up, highlight the box next to **Show at Power-up**. Press **ENTER** to place a check mark in the box. To hide the welcome information at start up, remove the check mark from the box.

## Interface Sub Tab

The Interface sub tab controls the input/output format used when connecting your unit to external devices. To open the Interface sub tab, press **MENU** twice to open the Main Menu. Select **Setup** from the vertical tab list. Highlight and select the Serial Data Format you want.

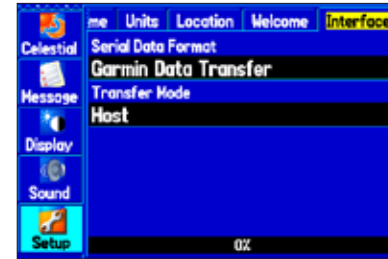

Interface Sub Tab

**Serial Data Format**—sets the data format to one of the following:

- **Garmin Data Transfer**—the proprietary format used to exchange data with a PC or another Garmin GPSMAP 496. Garmin Data Transfer is disabled when the USB is connected and the unit automatically switches to USB format. When the USB is disconnected, the USB field changes to Transfer Mode.

- **GARMIN DGPS**—used to connect the GPSMAP 496 with a Garmin DGPS beacon receiver.
- **Garmin Remote Sonar**—supports the input/output of a Garmin remote sonar device.
- **NMEA In/NMEA Out**—supports the input/output of standard NMEA 0183 version 3.01 data and sonar NMEA input support for the DPT, MTW, and VHW sentences.
- **Aviation In**—the proprietary format used for connection to a Garmin panel-mounted GPS receiver. Allows the GPSMAP 496 to show a Go To or route selected on the panel-mounted GPS receiver. This eliminates the need to enter the destination on both units.
- **Aviation In/NMEA & VHF Out**—receives aviation data and transmits out both NMEA data, at 9600 baud, and VHF frequency tuning information to a Garmin Nav/Comm radio. See [page 147](#).
- **TIS In**—receives TIS data from a Garmin Mode S transponder. See [page 147](#).
- **TIS In/NMEA & VHF Out**—receives TIS data and transmits out both NMEA data, at 9600 baud, and VHF frequency tuning information to a Garmin Nav/Comm radio. See [page 147](#).
- **RTCM In**—allows Differential GPS (DGPS) input using a standard RTCM format.

- **RTCM In/NMEA Out**—allows Differential GPS (DGPS) input using a standard RTCM format and also provides NMEA 0183 version 3.01 output.
- **RTCM In/Text Out**—allows Differential GPS (DGPS) input using a standard RTCM format and also outputs simple text data that includes, data, time, location, and velocity.
- **Text Out**—allows the unit to output simple text data that includes, data, time, location, and velocity. The Baud can be set to 1200, 2400, 4800, or 9600.
- **None**—provides no interfacing capabilities.

If you select GARMIN DGPS or RTCM In/NMEA Out format, you can control a differential beacon receiver directly from your GPSMAP 496 using the Interface sub tab. You can have the unit automatically scan for the DGPS beacon signal, or you can enter the beacon frequency and bit rate on the unit, and the information is used to tune the beacon receiver. If you use a DGPS receiver, WAAS capability is automatically turned off.

### To have the unit automatically scan for a frequency:

1. With the unit set to **GARMIN DGPS** or **RTCM In/NMEA Out**, use the **ROCKER** to highlight the **Beacon** field and press **ENTER**.
2. Highlight **Scan**, and press **ENTER**. The numbers in the **Frequency** field change as the unit scans from 284 kHz to 325 kHz, 200 bit rate, then 100, at 6 second intervals.

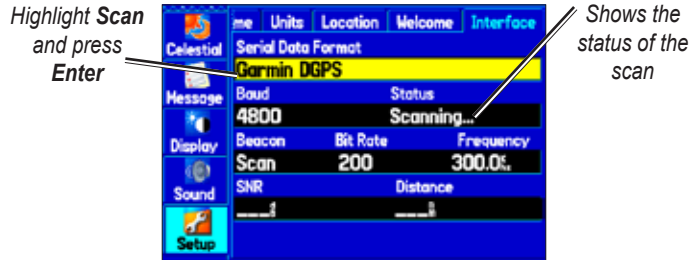

Interface tab of the Setup tab with GARMIN DGPS selected

The Status field shows one of the following:

- **Tuning**—the unit is attempting to tune to the specified frequency and bit rate.
- **Scanning**—the unit is automatically scanning through the frequencies and bit rates.
- **Receiving**—the unit is receiving DGPS signal and ready for operation.
- **Check Wiring**—the unit is not making connection with DGPS receiver.

### To restart the scan:

1. Press **MENU**.
2. Highlight **Restart Scan**, and press **ENTER**.

**To manually enter a frequency and bit rate:**

1. With the unit set to **GARMIN DGPS** or **RTCM In/NMEA Out**, use the **ROCKER** to highlight the **Beacon** field, and press **ENTER**.
2. Highlight **User**, and press **ENTER**.
3. Highlight the **Frequency** or **Bit Rate** field, press **ENTER**, and enter a frequency or bit rate. Press **ENTER** when done.

When the unit is receiving a DGPS signal, the SNR (Signal to Noise Ratio) and Distance fields show data. The SNR range is 0 dB to 30 dB, with 30 being the best. The Distance may or may not show data, based on the signal being broadcast from the DGPS site.

The DGPS beacon transmitters are operated by the United States Coast Guard (or similar government agency in other countries), which is responsible for their accuracy and maintenance. For DGPS transmitter problems or to find the most updated list of frequencies and coverage areas, contact your local USCG or see their Web site ([www.navcen.uscg.mil](http://www.navcen.uscg.mil)).

**Advanced NMEA Output Setup**

If you are going to interface the GPSMAP 496 with another piece of equipment (such as a radar or autopilot), the unit needs to be set to output NMEA data. The NMEA data transmission can be customized to keep the output rate at two seconds. If too many NMEA sentences are selected the unit can take longer than two seconds to update. You can also set the rate to **Fast** to output a minimum number of NMEA

sentences at 1-second intervals.

**To access the Advanced NMEA Output Setup:**

1. Press **MENU** twice to open the Main Menu.
2. Use the **ROCKER** to select **Setup** from the vertical tab list.
3. Select **Interface** from the row of tabs along the top.
4. Highlight the field below **Serial Data Format**. Press **ENTER**.
5. Select **NMEA In/NMEA Out**. Press **ENTER**.
6. Press **MENU** to open the options menu. Select **Advanced NMEA Setup**, and press **ENTER**.

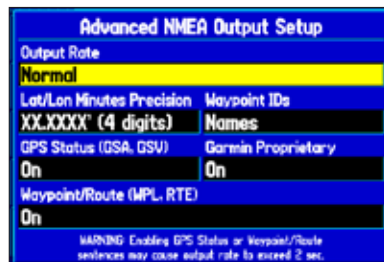

**Advanced NMEA Output Setup**

The Advanced NMEA Output Setup Page allows you to set the output rate, change the precision of the Lat/Lon minutes, set Waypoint IDs to names or numbers, as well as turn on and off the GPS status, the GARMIN Proprietary sentences, and Waypoint/Route (WPL, RTE).

GPSMAP 496 NMEA Sentence Output (NMEA version 3.01 compliant):

- Always transmitted: GPRMC, GPGGA, GPGLL, GPBWC, GPVTG, GPXTE, GPRMB
- Switchable sentences: GPGSA, GPGSV, GPWPL, GPRTE
- GARMIN proprietary: PGRME, PGRMZ, PGRMM, PGRMH

## Using XM WX Weather

This section describes how to use XM WX Weather with your GPSMAP 496. You must have a GXM 30A antenna plugged into the USB port on the back of the unit to receive the XM signal. If you do not have a subscription to XM WX Weather, the features described in this section work only when the GPSMAP 496 is in Simulator Mode (see [page 11](#)).



**NOTE:** You must have a subscription to XM WX Weather to use features described in this section. For more information about subscribing to XM WX Weather, see [page 180](#).

You can view XM WX Weather on your GPSMAP 496 in one of three ways:

- To view all weather information on the map, Use the Map Page.
- To view a specific weather feature such as NEXRAD Radar or Storm Cells, for example, you can use the Weather tab on the Main Menu. For more information, see [page 102](#).
- To view current weather conditions and forecast information for your current location or a specific location, use the Weather Data option on the Find menu. For more information, see [page 133](#).



**CAUTION:** NEXRAD weather data is to be used for long-range planning purposes only. Due to inherent delays and relative age of the data that can be experienced, NEXRAD weather data cannot be used for short-range avoidance of weather.

## Viewing XM WX Weather

From the Map Page, you can turn weather information on or off.

### To turn XM Weather on or off on the Map Page:

Press and hold **MENU/Wx** to toggle XM Weather on or off.

OR

Press **MENU**, select **Hide (Show) Weather**, and then press **ENTER**.



Map Page with XM WX Weather turned on



**NOTE:** XM Weather data is not saved between power cycles in the unit. If the GPSMAP 496 is turned off, the unit must reload the data.

## Setting XM WX Weather Options

Use the options menu on the Map Page to adjust the way weather items appear on the Map Page. Four tabs—Weather, Avtn Wx, Srfc Wx, and Mrn Wx—allow you to adjust what weather items appear on the Map Page, and the zoom range at which they appear. For detailed information about specific weather features, see the *GXM 30/30A Owner's Manual*.

You can view a specific weather feature, such as NEXRAD Radar or Storm cells, through the Weather Explorer tab on the Main Menu. For more information, see [page 102](#).

### To set up weather options on the Map Page:

1. From the Map Page, press **MENU** to open the options menu.
2. Highlight **Set Up Map**, and press **ENTER**.



Map Page Options Menu

3. Press left or right on the **ROCKER** to highlight the **Weather**, **Avtn Wx**, **Srfc Wx**, or **Mrn Wx** tab.
4. Press up or down on the **ROCKER** to highlight the field you want to change, and press **ENTER**.
5. Press **PAGE** or **QUIT** to exit.

## Weather Explorer Tab

Use the Weather Explorer tab on the Map Setup tab on the Map Page to turn XM WX Weather data on or off, and to set the zoom range at which the information first appears on the Map Page.



Weather Explorer tab

**Weather Data**—toggles XM WX Weather data on or off on the Map Page.

**NEXRAD Radar, Satellite Mosaic, Lightning, Storm Cells, Hurricanes**—sets the zoom range at which the feature first appears on-screen. Select **Auto**, **Off**, or **20 ft to 800 nm**.

## Avtn Wx Tab

Use the Avtn Wx tab to set the zoom range at which aviation weather information first appears on the Map Page.



Avtn Wx Tab

**METAR, AIRMET, SIGMET**—sets the zoom range at which each feature first appears on-screen. Select **Auto**, **Off**, or **20 ft to 800 nm**.



## Srfc Wx Tab

Use the Srfc Wx tab to set the zoom range at which surface weather information first appears on the Map Page.

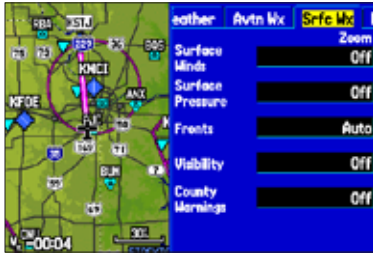

Srfc Wx Tab

**Surface Winds, Surface Pressure, Fronts, Visibility, County Warnings**—sets the zoom range at which each feature first appears on-screen. Select **Auto**, **Off**, or **20 ft to 800 nm**.

## Mrn Wx Tab

Use the Mrn Wx tab on the Map Page Options to set up marine weather options.

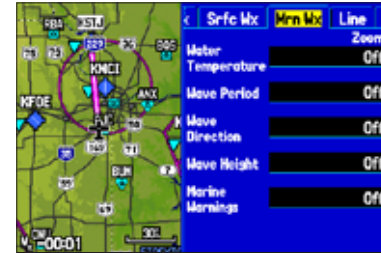

Mrn Wx Tab

**Water Temperature, Wave Period, Wave Direction, Wave Height, Marine Warnings**—sets the zoom range at which each feature first appears on-screen. Select **Auto**, **Off**, or **20 ft to 800 nm**.

## Using the Weather Tab

Use the Weather tab to view individual weather items without turning all other weather features on or off. For example, you can select **Storm Cells** to view only storm cells on the Map window that appears on the Weather tab. When you close the Main Menu and return to the Map Page, all of your previously selected weather features still appear on the Map Page.

Based on which mode you are in, different options might appear. Use the In and Out keys to zoom in or out on the map.



Weather Explorer tab with Storm Cells

### To view a specific XM WX Weather Information Type:

1. Press **MENU** twice to show the Main Menu.
2. Use the **ROCKER** to highlight the **Weather Explorer** tab.

3. Press right on the **ROCKER** to highlight the **Weather Information Type** field.
4. Press up or down on the **ROCKER** to select (scroll through) the weather information type you want to view. The map refreshes to show only the selected information type.

From the Weather tab, you can view the current conditions or forecast on the map for the next 12, 24, 36, or 48 hours.

### To view the forecast map:

1. In the **Weather Information Type** field, press up or down on the **ROCKER** to highlight **Forecast**. The Map window shows the forecast on in the Map window.

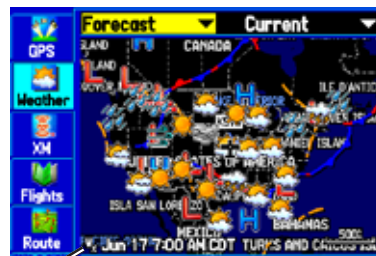

Age of the weather report Forecast Map

2. Press right on the **ROCKER** to highlight the field to the right of **Forecast**, and press **ENTER** to display a list of forecast options.

- Highlight the forecast you want to view—**Current, 12 Hour, 24 Hour, 36 Hour, or 48 Hour**, and press **ENTER**. The Map window on the Weather Explorer tab is updated with forecast information for the time you selected.

The age of the weather report appears in the bottom-left corner of the Map window on the Weather Explorer tab.

#### To pan the map:

Press and hold the **MENU/Wx** key, or press **MENU**, highlight **Show Map Pointer**, and press **ENTER**. The panning arrow appears so you can pan the map to view other map areas.

## Weather Options

Use the options menu on the Weather Explorer tab to select weather options for the Map window on the Weather Explorer tab.

#### To select weather options:

- Press **MENU** twice to open the Main Menu.
- Highlight the **Weather** Explorer tab, and press **MENU**.

**Declutter On (Off)**—allows you to toggle unwanted weather items on or off on the Map window.

**Animate Weather (Stop Animation)**—animates NEXRAD Radar and Satellite Mosaic weather. When selected, a series of frames appears, each displaying a different time in the lower left-corner of the map. Up to six frames appear, beginning with the oldest to the most current weather data.

**Show Map Pointer**—allows you to switch from pan mode to pointer mode and display the map pointer in the map area so you can pan the map.

**Weather Legend**—shows the color legend for Radar, Fronts, METARs, County Warnings, and Other features. Press right or left on the **ROCKER** to view each weather legend.



**Weather Legend**

## Viewing Additional XM WX Weather Information

The XM Tab contains the Information sub tab. Use the Information sub tab to view the radio ID, service level information, and weather products available on your XM subscription.



Information Sub Tab

The Information sub tab contains the following information:

**Radio ID**—contains the eight-digit ID number of the radio built into the GXM 30A. This is the number to provide to XM to activate your XM subscription.

**Service Level**—shows the XM WX Weather subscription plan you purchased.

**Weather Products**—shows a list of all weather features you can access based on your subscription plan. Shows age of weather data in minutes.

## Accessing GXM 30A Antenna Information

To view information about your GXM 30A antenna:

1. From any page, press **MENU** twice to show the Main Menu.
2. Press up or down on the **ROCKER** to select the XM tab.
3. Press right on the **ROCKER** to select the Information sub tab.
4. Press **MENU**.
5. With Antenna Information highlighted, press **ENTER**. A window appears displaying the software version loaded to your GXM antenna.



6. Press **ENTER** to close the window.

## Finding Weather Information

You can use the Find menu to access weather information for your current location or from another location on the map. By selecting the Weather Data option on the Find menu, you can view the current conditions, forecast information, sea surface conditions, and weather bulletins. For more information about the Find menu, see “[Finding an Item](#)” beginning on [page 58](#).

### To find weather information for your current location:

1. From any page, press **FIND**.
2. Select **Weather Data**, and press **ENTER**. The Weather From Current Location Page appears.



Weather From Current Location

3. Highlight the **Forecast** tab to view the weather forecast for your current location.

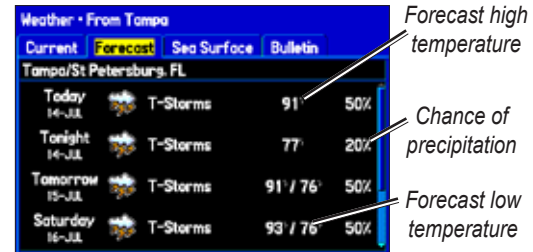

Weather Forecast

4. Highlight the **Sea Surface** tab to view sea surface information.

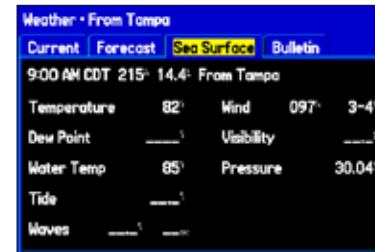

Sea Surface Information

5. Highlight the **Bulletin** tab to view marine weather bulletins.

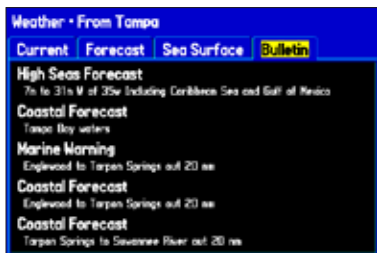

Marine Weather Bulletins

6. Highlight a weather bulletin and press **ENTER** to view the full text of the marine weather bulletin.

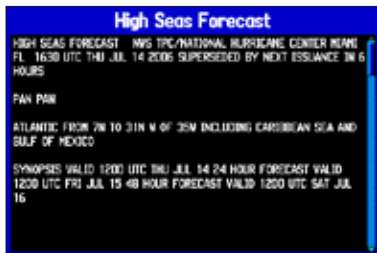

Full Text Marine Weather Bulletin

You can find weather forecast information for a different location.

**To find weather data for a different location:**

1. Press **MENU** on the Weather From Current Location Page.
2. With **Near Other** highlighted, press **ENTER**.



3. Move the map pointer to a different location, and press **ENTER**. The Weather From (New Location) Page appears with weather information for the selected location.
4. Press **MENU**, highlight **Near Current Location**, and then press **ENTER** to return to the forecast for your current location.

## Setting up and Using Sonar

This section covers the additional sonar options for the GPSMAP 496 when used in conjunction with a GSD 20 or GSD 21 Sounder Module. Read the *GSD 20/GSD 21 Installation Instructions* to properly install the sounder module. When you turn on your GPSMAP 496, the GSD 20/GSD 21 automatically turns on.



**NOTE:** You **MUST** have a GSD 20 or GSD 21 installed and connected to your GPSMAP 496 to use the sonar features.

The Sonar Page is added to the end of the page sequence when you are in Marine Mode. To view the Sonar Page, press **PAGE** or **QUIT** repeatedly until it is shown.

### Showing Sonar on the Map Page

You can change the layout of the Map Page to show a split screen to show the sonar and Map Page. You must be in Marine Mode to use the sonar feature.

#### To show the Sonar Page on the Map Page:

1. Press and hold **PAGE**. Highlight **Marine**, and press **ENTER**.
2. Press **PAGE** or **QUIT** to show the Map Page.

3. Press **MENU**. Use the **ROCKER** to highlight **Set up Page Layout**, and press **ENTER**.
4. Highlight **Map with Sonar**, and press **ENTER**.

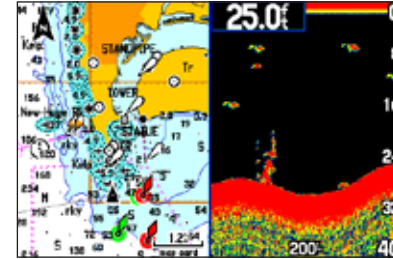

Map Page with Split Screen

#### To resize the Map Page sonar split screen:

1. After displaying the Sonar and Map Page together in the split screen, as described in the previous steps, press **MENU**.
2. Highlight **Size Split**, and press **ENTER**.
3. Use the **ROCKER** to move the vertical double-arrow right or left until the screen is divided how you want it.
4. Press **ENTER** to complete the size split.
5. To stop resizing the screen, simply press **QUIT**. You can also press **MENU**, highlight **Stop Resizing**, and press **ENTER** to stop resizing the screen and retain the previous split setting.

## Using the Sonar Page

When combined with a GSD 20 or GSD 21 Sounder Module, your GPSMAP 496 becomes a powerful fishfinder/flasher with the Sonar Page. If a GSD 20 or GSD 21 is attached, but the unit does not detect a transducer, a “Sonar Turned Off” message appears across the Sonar Page. If a GSD 20 or GSD 21 is not attached, the Sonar Page only appears when the unit is in Simulator Mode.

The middle of the page contains a right-to-left moving sonar image of the water beneath your boat. Items appear as they pass under your transducer. Those items on the right side of the screen are closer to you than those on the left. Along the right side of the screen is an adjustable scale that reflects the depth of the area being shown. The top-left corner shows the Adjustment Option, the depth, and the water temperature.

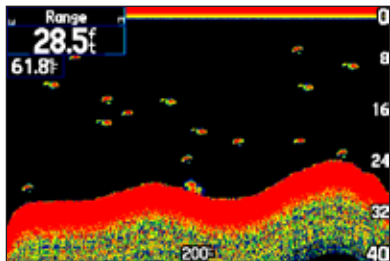

Sonar Page

The sonar returns show as red (strongest), then orange (strong), yellow (medium), green (weaker), and blue (weakest). The **Fish Symbols** option allows you to view the actual sonar data, a fish symbol or a combination of both. When the unit is set to **Dual**, the appearance of the fish symbols changes. Fish symbols from the center of the beam (200 kHz) are solid (or narrow arches), but the returns from the edges of the beam (50 kHz) are hollow (or wide arches).

The Sonar Page can also be set to show a split screen view of a zoomed portion of the sonar, bottom lock (screen scaled from the bottom up), or a combination of these options. For example, you can choose to show dual frequency at a 2X zoom (Dual 2X) on one half and normal range dual frequency (Dual) on the other half. The current display mode is shown at the bottom of each sonar screen.



## Adjusting the Sonar Page

The Adjustment Menu allows direct access to the settings and features most commonly used on the Sonar Page. There are 10 main adjustment options available: Range, Zoom, View, Gain, Target Level, Whiteline, Frequency, Depth Line, Noise Reject and Scroll. Use the **ROCKER** and **ENTER** keys to make all adjustments. The currently selected option appears in the upper left corner.

### To select an adjustment option:

Use one of the following methods to select an adjustment option:

- Press the **ROCKER** right or left to scroll through the adjustment options. When the adjustment option is shown, press **ENTER**.
- Press **MENU**, highlight **Adjustments**, and press **ENTER**. Use the **ROCKER** to highlight the adjustment, and press **ENTER**.

When you have selected an adjustment option, press the **ROCKER** up or down to change the setting.

You can also press **MENU**, and highlight the shortcut setting to quickly change to commonly used settings/values.

Press **ENTER** to accept the new setting (or press **QUIT** to cancel) and return to the Sonar Page.

## Adjustment Options

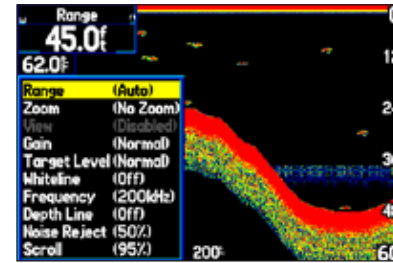

Sonar Adjustments

**Scroll**—adjusts the rate that the sonar screen scrolls from right to left. If you are sitting still or the sonar screen is moving too fast, slow the scroll rate or pause the scrolling.

**Range**—sets the depth range used for viewing. The unit can be set to automatically track the bottom or set to a user-specified depth range.

**Zoom**—used to quickly select a zoom scale or to split the screen. When a scale other than **No Zoom** is selected, the Adjustment Menu shows a new selection labeled **View** or **Span**. The Zoom function is divided into six levels:

- **2X Split**—shows two reduced-size sonar pictures at the same time. The right half of the screen shows the complete sonar picture at its original scale. The left half shows a portion of the original picture at 1/2 depth scale.
- **2X Zoom**—shows the 2X zoomed picture on the full screen.
- **4X Split**—shows two reduced pictures, the right at the original depth scale and the left at 1/4 the original depth scale.
- **4X Zoom**—shows the 4X zoomed picture on the full screen.
- **Btm (Bottom) Split**—shows two reduced pictures, the right at the original depth scale and the left showing sonar returns from the bottom up. All target depths read as a distance from the bottom.
- **Btm (Bottom) Lock**—shows returns from the bottom up on the full screen.



---

**NOTE:** Quickly zoom in and out of the Sonar Page by pressing the **In** and **Out** keys. Stop the zoom function by pressing the **Out** key until the **No Zoom** setting appears.

---

**View/Span**—available when a **Zoom** scale other than **No Zoom** is selected. The **View** or **Span** setting is used to change the viewing range of a zoomed screen. If the screen is 2X or 4X split, only the zoomed portion on the left side of the screen is affected by the change. If the screen is Bottom Split or Bottom Lock, **Span** adjusts how far off the bottom the unit shows data.

**Gain**—allows you to control the sensitivity of the unit's receiver, which provides flexibility in what is shown. To see more detail, increase the receiver sensitivity by selecting a higher gain. If there is too much detail or if the screen is cluttered, select a lower gain.

**Target Level**—adjusts which colors are used to show sonar information. A **Color Bar** appears on the right side of the screen as you adjust this setting. A higher percentage results in more strong-signal colors shown on the sonar screen. A lower percentage results in more weaker-signal colors shown on the sonar screen. This setting does not increase or decrease the unit Gain.

**Whiteline**—controls how the unit shows information about the bottom type (hard or soft). With the Whiteline Off, the bottom return shows as red. Set Whiteline at **Normal** or **1–100%** to determine bottom hardness. See [page 145](#) for more information.

**Frequency**—allows you to choose a transducer frequency. Frequency refers to the “pitch” of the sound that the transducer sends and receives.

**Depth Line**—adds a horizontal depth line across the screen that is used to measure the depth of underwater objects. The depth of the line appears in a box on the right side of the line. Press up or down on the **ROCKER** to move the line on the Sonar Page.

**Noise Reject**—helps filter unwanted noise from the Sonar Page. The Noise Reject can be turned **Off**, set to **Normal** (automatically adjusts for optimum viewing) or to a fixed **1–100%** setting. When setting the Noise Reject, remember that a higher noise rejection setting is less likely to show fish or structures.

## Resizing the Split Screen

You can adjust the way the split screen is shown. This option is only available when a zoom scale other than **No Zoom** is selected.

### To resize the Sonar Page split screen:

1. From the Sonar Page split screen, press **MENU**.
2. Using the **ROCKER**, highlight **Size Split**, and press **ENTER**.
3. Move the horizontal double-arrow left or right using the **ROCKER** until the vertical width line shows, then press **ENTER**.
4. If you want to cancel this operation, press **QUIT** or press **MENU**, highlight **Stop Resizing**, and press **ENTER**.

## Using the Pointer on the Sonar Page

You can show the pointer (arrow)  to reference sonar items and mark underwater waypoints. This makes it easier to find and use an object such as a stump for a future fishing location. When using this feature, the Sonar Page pauses. The depth continues to update while the screen pauses, but the unit does not show any new sonar data until the Sonar Page resumes scrolling.

### To mark an underwater waypoint:

1. From the Sonar Page, press **MENU**, highlight **Show Pointer**, and press **ENTER**.
2. Use the **ROCKER** to move the pointer to the location you want to mark. Press **ENTER**. The New Map Waypoint Page appears.
3. To change the name, symbol, or depth, highlight the appropriate field and press **ENTER**. Make your changes, and press **ENTER** when done.
4. When finished, highlight **OK**, and press **ENTER**.
5. To return to the standard Sonar Page, press **QUIT**; or press **MENU**, highlight **Hide Pointer**, and press **ENTER**.

## Setting Up the Sonar Page

Use the Sonar tab in the Main Menu to set up the Sonar Page. Press **MENU** two times to open the Main Menu. Select **Sonar** from the vertical row of tabs on the left, then select **Setup** from the row of tabs along the top of the screen.



Sonar Tab of the Main Menu

**Fish Symbols**—select how the Sonar Page shows underwater targets and background information. If you select **Off**, the unit shows all of the available information about the underwater environment. If you select a fish symbol, the Sonar Page shows only the information related to that symbol.

**Water Type**—select the water type in which you are boating. Since sound waves travel through Fresh and Salt water at different rates, it is necessary to select the **Water Type** to ensure accurate readings on the unit.

**Depth Number**—select how efficient the digital depth update rate is. **Fast Sonar update** updates quicker and is recommended for low-noise water deeper than 50 feet. **Auto** is best for shallow water or high-noise areas, has a slower screen update, and is best used if you travel a wide variety of depths.

If the unit is unable to track the bottom for any reason, the digits in the depth window flash on and off to alert you that the unit is not tracking the bottom.

**Map Split Sonar Detail**—select how much detail is shown on the Map Page with the sonar shown. **Full Range** shows data using the **Range** setting of the Sonar Page, regardless of **Zoom** or **Bottom Lock**. **Maximum Detail** shows any **Zoom** or **Bottom Lock** data from the Sonar Page.

**Keel Offset**—enter the surface reading for the depth of a keel. This makes it possible to measure depth from the bottom of your keel instead of from the transducer's location. Enter a positive number to offset for a keel. It is also possible to enter a negative number to compensate for a large vessel that draws several feet of water. The **Keel Offset** is reflected in the depth reading.

**Transducer**—select the type of transducer that you are using. If you are using a speed-capable transducer/sensor, select **Temp, Spd**.

## Calibrating the Water Speed

If you select **Temp, Spd** is for the **Transducer** option on the Sonar Setup tab, you also need to calibrate the water speed to ensure that the **Water Speed** shown on your unit is accurate. The calibration should take place in water having little or no current.

The unit automatically uses the GPS ground speed, if it is available, for comparison on the calibration. If a GPS ground speed is not available, use either your boat's speedometer reading (not always accurate) or a stopwatch to determine your speed over a certain distance. To find out your speed, divide the distance by the time.

### To calibrate the water speed:

1. From the Sonar tab, Setup sub tab, use the **ROCKER** to highlight **Calibrate Water Speed**, and press **ENTER**.
2. Bring the boat to a cruising speed. Both the top ground and uncalibrated water speeds are shown at the bottom of the calibration window. Note your top speed, then stop the boat, and press **ENTER**.

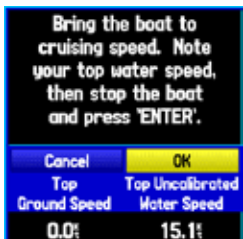

Calibrating the Water Speed

3. By default, the top ground speed is automatically shown. If a ground speed is not available, the top uncalibrated water speed is used instead. If the new speed is correct, highlight **OK**, and press **ENTER**.

If you want to manually enter a calibration, press **ENTER** while the speed is highlighted, enter a new speed, and press **ENTER**.

If the boat is not moving fast enough or the speed sensor is not outputting a speed, “Boat Is Not Moving Fast Enough To Calibrate” shows at the bottom of the screen. Check that the speed sensor wheel is moving or safely increase boat speed. If there is a problem with the speed sensor or if a speed sensor is not installed, “Water Speed Sensor Is Not Working” appears at the bottom of the screen. Check connections of speed sensor cables.

## Setting Up the Sonar Display

You can set up how the sonar information is shown on the screen. Press **MENU** two times to open the Main Menu. Select **Sonar** from the vertical row of tabs on the left, then select **Display** from the row of tabs along the top of the screen.

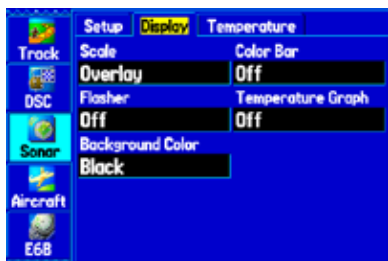

**Sonar Display Setup Tab**

**Scale**—select how and where you want the depth scale shown.

**Color Bar**—select **On** to show a gradient scale of the current **Target Level** setting on the Sonar Setup tab.

**Flasher**—select **On** to show a graphic Flasher representation on the far right side of the sonar screen. This graphic Flasher shows structure and bottom returns much the same as a true Flasher.

**Temperature Graph**—select **On** to show a temperature graph along the bottom of the Sonar Page.

**Background Color**—select the color for the Sonar Page and the sonar on the Map split.

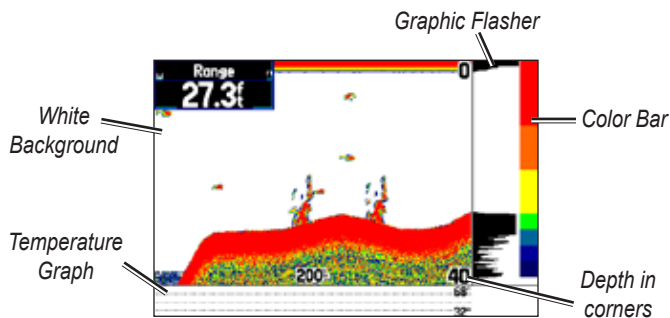

**Sonar Page with the Sonar Page Settings Changed**

## Understanding Sonar

The transducer mounted on your vessel transmits sound waves toward the bottom of a lake, stream, or seabed in a cone-shaped pattern. When a transmitted sound wave strikes an underwater object—such as the bottom, a piece of structure, or a fish—sound is reflected back to the transducer. The transducer collects the reflected sound waves and sends the data to the GPSMAP 496 to be processed and shown. The underwater data is shown on the Sonar screen in the order that it is returned: first returned is the first on the screen.

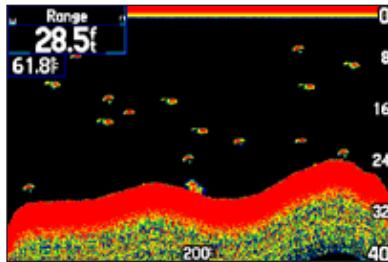

**Sonar Page**

Generally speaking, if the only thing between the transducer and the bottom is water, the first strong return comes from the bottom directly below the transducer and sets the bottom level. Weaker, secondary returns provide the detailed data. Stronger returns appear on the screen in darker colors, with red being the strongest return.

## Understanding the Sonar Display

One of the first things to understand about sonar is that the transducer sends a beam down to the bottom of the water, much like the beam of a flashlight. The beam starts small near your vessel and expands as it gets to the bottom. Refer to “Transducer Coverage” for more detailed information.

The Sonar Page does not show a three-dimensional representation of the underwater environment; the screen is in two-dimensions, much like if you took a picture of an aquarium. Only the depth of the item in the water is shown. The Sonar Page does not show you where an item is located horizontally in the water, as shown in the drawings below. The fish is not directly above the tree in reality, but it can look like it is on the Sonar Page.

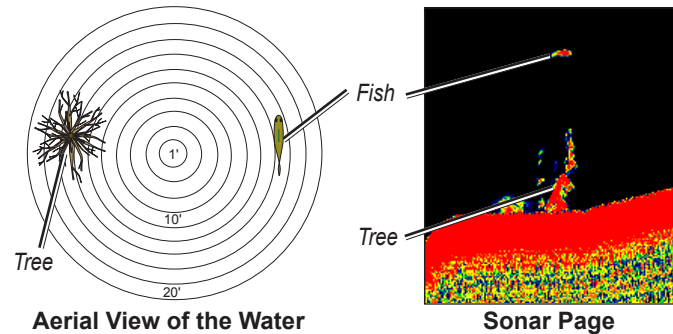

**Aerial View of the Water**

**Sonar Page**

## Transducer Coverage

The area covered by the transmitted sound waves is determined by the cone angle of the transducer and the water depth. The wide cone angles ( $40^\circ$ ), associated with low frequencies (50 kHz) provide a large coverage area for finding fish within a coverage width that is approximately  $2/3$  of the water depth. However, this also means that wide cone angles produce less bottom detail and resolution. As shown in the drawing on the near right, the  $40^\circ$  cone angle produces a coverage area of approximately a 20-foot diameter circle at a 30-foot depth.

The narrow cone angles ( $10^\circ$ ) associated with the high frequencies (200 kHz) provide better bottom resolution and crisper detail, but cannot show a large coverage area for finding fish. The  $10^\circ$  cone angle provides a coverage width that is approximately  $1/5$  of the water depth. As shown in the drawing on the far right, the  $10^\circ$  cone angle produces a coverage area of approximately a 6-foot diameter circle at a 30-foot depth.

Dual frequency mode combines both frequencies to get the best coverage area and contour/depth readings.

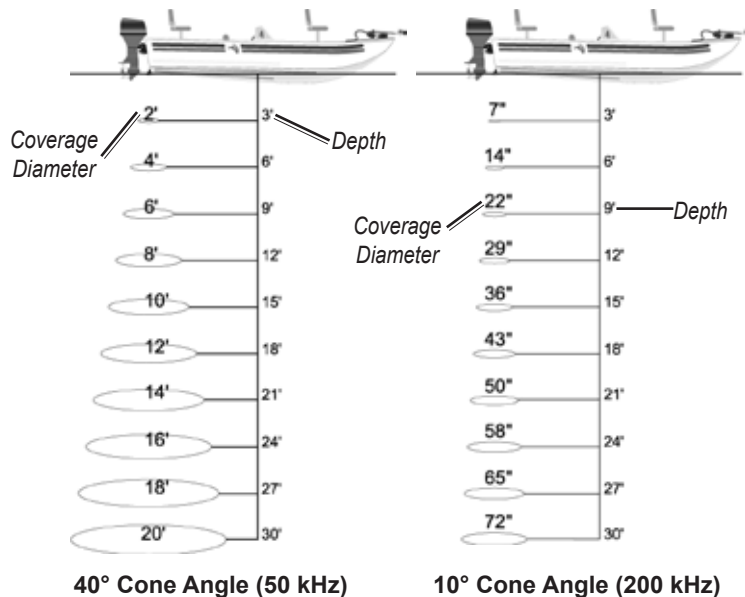



## Whiteline

The GSD 20 or GSD 21 Sounder Module can help you determine whether the bottom is hard or soft. When the sonar sound waves are reflected back by the bottom, a hard bottom returns a stronger signal than a soft bottom. A thin whiteline indicates a softer bottom, while a thick whiteline indicates a harder bottom. Normally, a red line is used to show the point where water meets the bottom. This line follows the bottom contour, along with any significant objects lying on the bottom. The unit uses the whiteline function to make the bottom layer information easier to distinguish.

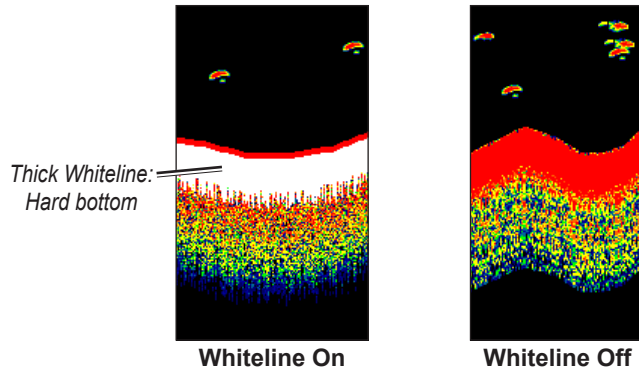

## Thermoclines

A rough definition of a thermocline is a break in water where the water temperature changes faster than the water above it. Thermoclines are shown as the weakest colors.

One of the unique features offered by Garmin is See-Thru<sup>®</sup> technology, which allows the GPSMAP 496 to hear both weak and strong signals simultaneously so as to identify fish returns under the toughest conditions, such as suspended in thermoclines or even hiding near structures. See-Thru technology allows the GSD 20 or GSD 21 Sounder Module to see through thermoclines and helps locate fish where they live.

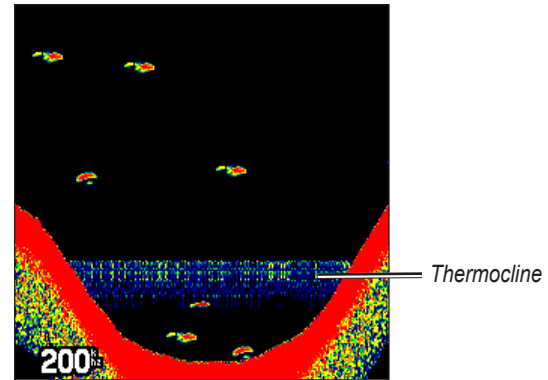

## Viewing the Sonar Temperature Tab



**NOTE:** You must be receiving proper sonar data from another device, such as a Garmin GSD 20 or GSD 21 Sounder Module, to view temperature information.

The Temperature sub tab provides a visual graph of water temperature changes over a period of time. The graph reads from right to left, so that the most recent temperature measured is shown on the far right side of the graph. The dotted lines within the graph indicate intervals in the temperature scale and the duration of time.



**NOTE:** Select **Temp** for the **Transducer** type in the Sonar Setup. See “[Setting Up the Sonar Page](#)” on [page 140](#) for more information.

Press **MENU** twice to open the Main Menu. Select **Sonar** from the vertical row of tabs on the left, then select **Temperature** from the row of tabs along the top of the screen.

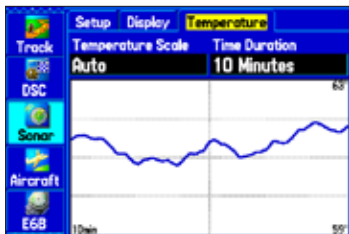

Temperature Tab

## Changing the Temperature Screen

The graph adjusts and shows the temperature changes according to the **Temperature Scale** and **Time Duration** settings.

**Temperature Scale**—select the degree span from the list. Select **Auto** to have the unit automatically determine the best range, or select a span of 2, 4, 6, 8 or 10 degrees.

**Time Duration**—set how fast or slow the temperature log scrolls: a shorter the time duration means a faster temperature log scroll. Select a duration from 1 minute to 2.5 hours.

## Reset the Temperature Graph

To reset the scale range for the temperature graph, press **MENU**, highlight **Reset Auto Scale**, and press **ENTER**. This is useful when the scale spans a large range due to extreme temperature changes. You can only reset the scale when you select **Auto** for the **Temperature Scale**.

To restore the temperature graph to defaults, press **MENU**, highlight **Restore Default**, and press **ENTER**.

# TIS

## (Traffic Information Service)

TIS provides a graphic representation of traffic advisory information in the cockpit for non-TCAS equipped aircraft. TIS is a ground-based service providing relative location of all ATCRBS (Air Traffic Control Radar Beacon System) Mode A and Mode C transponder-equipped aircraft within a specified service volume. The TIS ground sensor uses real-time track reports to generate traffic notification. TIS Traffic is available to aircraft equipped with a Mode S Data Link such as the Garmin GTX 330 Transponder. TIS Traffic from a GTX 330 Transponder can then be shown on the GPSMAP 496. Surveillance data includes all transponder-equipped aircraft within the coverage volume. Aircraft without an operating transponder are invisible to TIS. TIS shows up to eight traffic targets within 7 nautical miles horizontally from 3,000 feet below to 3,500 feet above the requesting aircraft. Refer to [page 159](#) for information on connecting your GPSMAP 496 to a GTX 330 Mode S transponder.



**NOTE:** How TCAS differs from TIS—the main difference between TIS and TCAS is the source of surveillance data. TCAS uses an airborne interrogator with a half-second update rate, while TIS uses the terminal Mode S ground interrogator and its Data Link to provide about a five-second update rate. The range accuracy of TIS and TCAS is similar.

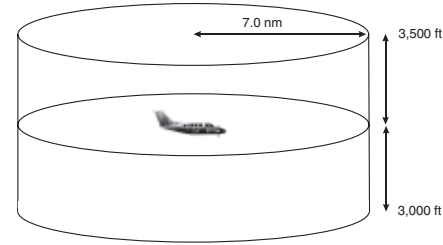

**TIS Coverage Volume (not to scale)**



**WARNING:** TIS is NOT intended to be used as a collision avoidance system and does not relieve the pilot responsibility to “see and avoid” other aircraft. TIS should not be used for avoidance maneuvers. TIS is intended only to assist in visual acquisition of other aircraft in VMC. Avoidance maneuvers are not recommended, nor authorized, as a direct result of a TIS alert.

While TIS is a useful aid to visual traffic avoidance, it has some system limitations that must be fully understood to ensure proper use. Many of these limitations are inherent in secondary radar surveillance. In other words, the information provided by TIS will be no better than that provided to ATC.

## TIS Limitations

TIS is NOT intended to be used as a collision avoidance system and does not relieve the pilot responsibility to “see and avoid” other aircraft. TIS should not be used for avoidance maneuvers during IMC or other times when there is no visual contact with the intruder aircraft. TIS is intended only to assist in visual acquisition of other aircraft in VMC. No recommended avoidance maneuvers are provided for, nor authorized, as a direct result of a TIS display or TIS advisory.

While TIS is a useful aid to visual traffic avoidance, it has some system limitations that must be fully understood to ensure proper use. Many of these limitations are inherent in secondary radar surveillance. In other words, the information provided by TIS will be no better than that provided to ATC. TIS only shows aircraft with operating transponders installed.

TIS relies on surveillance of the Mode S radar, which is a “secondary surveillance” radar similar to the ATCRBS. TIS operation may be intermittent during turns or other maneuvering. TIS is dependent on two-way, “line-of-sight” communications between the aircraft and the Mode S radar.

Whenever the structure of the client aircraft comes between the transponder antenna (usually located on the underside of the aircraft) and the ground-based radar antenna, the signal may be temporarily interrupted. Other limitations and anomalies associated with TIS are described in the AIM, Section 1-3-5. Refer to [page 159](#) for wiring information.



---

**NOTE:** Garmin is not responsible for Mode S geographical coverage. Operation of the ground stations is the responsibility of the FAA. Refer to the Aeronautical Information Manual for a Terminal Mode S Radar Site Map covering the U.S.

---



---

**NOTE:** TIS is unavailable at low altitudes in many areas of the U.S., particularly in mountainous regions. Also, when flying near the “floor” of radar coverage in a particular area, intruders below the client aircraft may not be detected by TIS.

---

TIS information is collected one radar scan prior to the scan during which the uplink occurs. Therefore, the surveillance information is approximately 5 seconds old. In order to present the intruders in a “real time” position, the TIS ground station uses a “predictive algorithm” in its tracking software. This algorithm uses track history data to extrapolate intruders to their expected positions consistent with the time of display in the cockpit. Occasionally, aircraft maneuvering causes this algorithm to induce errors in the GPSMAP 496 screen. These errors primarily affect relative bearing information and traffic target track vector (it will lag); intruder distance and altitude remains relatively accurate and may be used to assist in “see and avoid.” Some of the more common examples of these errors include:

- When client or intruder aircraft maneuvers excessively or abruptly, the tracking algorithm can report incorrect horizontal position until the maneuvering aircraft stabilizes.
- When a rapidly closing intruder is on a course that crosses the client aircraft course at a shallow angle (either overtaking or head on) and either aircraft abruptly changes course within  $\frac{1}{4}$  nm, TIS may show the intruder on the opposite side of the client than it actually is.
- 

These are relatively rare occurrences and are corrected in a few radar scans once the course has stabilized.

Users of TIS can render valuable assistance in the correction of malfunctions by reporting their observations of undesirable performance. Reporters should identify the time of observation, location, type and identity of aircraft, and describe the condition observed; the type of transponder processor and software in use can also be useful information. Since TIS performance is monitored by maintenance personnel rather than ATC, it is suggested that malfunctions be reported in the following ways:

- By telephone to the nearest Flight Service Station (FSS) facility.
- By FAA Form 8000-7, Safety Improvement Report, a postage-paid card designed for this purpose. These cards can be obtained at FAA FSSs, General Aviation District Offices, Flight Standards District Offices, and General Aviation Fixed Based Operations.

The GPSMAP 496 supports TIS input from a Garmin Mode S transponder, such as the GTX 330.

### To configure TIS input:

1. Press **MENU** twice. The Main Menu appears.
2. Highlight the **Setup** tab.
3. Use the **ROCKER** to select the Interface sub tab.
4. Highlight the **Serial Data Format** field, and use the **ROCKER** to select **TIS In**.

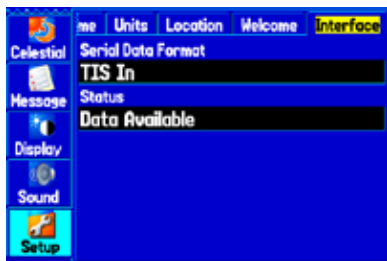

The status field indicates one of the following messages:

- **Waiting For Data**—searching for a valid TIS data stream.
- **Data Available**—receiving TIS data from the transponder.
- **Data Unavailable**—connection to transponder established, but TIS service is unavailable.
- **Lost Connection**—an error occurred or the connection to the transponder was lost.

## TIS Symbology

TIS traffic is shown on the GPSMAP 496 according to TCAS symbology, graphically shown on an alert window, and on the moving Map Page. A Traffic Advisory (TA) symbol appears as a solid yellow circle. All other traffic is shown as a hollow white diamond. Altitude deviation from own aircraft altitude is shown above the target symbol if traffic is above own aircraft altitude, and below the symbol if they are below own aircraft altitude. Altitude trend is shown as an up arrow (>+500 ft/min), down arrow (<-500 ft/min), or no symbol if less than 500 ft/min rate in either direction.



A TIS audio alert is generated whenever the number of Traffic Advisories on the GPSMAP 496 screen increases from one scan to the next. Limiting Traffic Advisories only reduces the “nuisance” alerting due to proximate aircraft. For example, when the first Traffic Advisories appear on the TIS display, the user is alerted audibly. So long as a single aircraft remains on the TIS display, no further audio alert is generated. If a second (or more) aircraft appears on the screen, a new audio alert is sounded.

If the number of Traffic Advisories on the TIS display decreases and then increases, a new audio alert is sounded. The TIS audio alert is also generated whenever TIS service becomes unavailable.

The following TIS audio alerts are available:

- **Traffic**—TIS traffic alert received.
- **Traffic Not Available**—TIS service is not available or out of range.



**NOTE:** TIS audio alerts can be turned off in the Main Menu Sound tab.

## Traffic Ground Track

Traffic ground track is indicated on the GPSMAP 496 screen by a “target track vector”, a short line shown in 45-degree increments, extending in the direction of target movement.

## Traffic Warning Window

When a traffic threat is imminent, the Traffic Warning Window is shown. The Traffic Warning Window shows a small thumbnail map. Press **QUIT** to go back to the previous page.



**NOTE:** The Traffic Warning Window is disabled when the aircraft ground speed is less than 30 knots or when on the approach leg of a route.

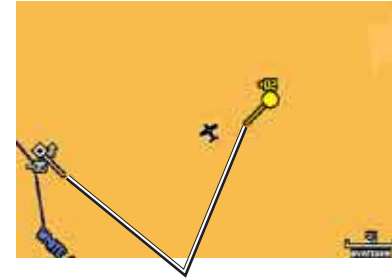

*Traffic Target Track Vector*



**Traffic Warning Window**

## Map Page

TIS traffic can be shown on the Map Page.

### To configure TIS Traffic on the Map Page:

1. Press **PAGE** until the Map Page appears.
2. Press **MENU**. The Map Page options menu appears.
3. Highlight **Set Up Map**, and press **ENTER**.
4. Highlight the **Map** sub tab.
5. Select **TIS Traffic**, and use the **ROCKER** to change the Zoom range.

## Highlighting TIS Traffic Using Map Page Panning

Another Map Page feature is panning. Refer to [page 31](#) for more information.

When the target pointer is placed on traffic, the traffic range and altitude separation are shown.



*Displaying traffic range and altitude separation using the Map Panning feature.*



## TIS Operational Procedures

TIS warns the user with voice and visual traffic advisories whenever it predicts an intruder to be a threat. The user should not start evasive maneuvers using information from the GPSMAP 496 screen or on a traffic advisory only. The display and advisories are intended only for assistance in visually locating the traffic, due to the lack in resolution and coordination ability. The flight crew should attempt to visually acquire the intruder aircraft and maintain a safe separation in accordance with the regulatory requirements and good operating practice. If the flight crew cannot visually acquire the aircraft, they should contact ATC to obtain any information that may assist concerning the intruder aircraft. Based on the above procedures, minor adjustment to the vertical flight path consistent with air traffic requirements are not considered evasive maneuvers.

The TIS Traffic Advisory (TA) should alert the crew to use additional vigilance to identify the intruding aircraft. Any time the traffic symbol becomes a yellow circle or a voice warning is announced, conduct a visual search for the intruder. If successful, maintain visual contact to ensure safe operation.

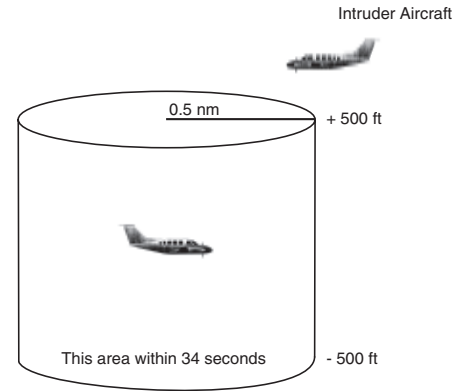

### Conditions for Traffic Advisories

TIS shows a Traffic Advisory (TA) on the GPSMAP 496 when an intruder aircraft approaches your aircraft on a course that intercepts (defined by a 0.5 nm horizontal radius and a relative altitude of  $\pm$  500 ft) your course within 34 seconds.

## VHF Comm

The GPSMAP 496 can also output frequency data to a Garmin aviation radio. Currently the two models supported are the SL30 nav/comm and the SL40 comm. Refer to [page 159](#) for wiring information.



**CAUTION:** This interface does not have an FAA installation airworthiness approval. If any abnormalities with SL 30/40 tuning or operation are encountered, disconnect the GPSMAP 496 from the SL 30/40 tuning interface.

### To configure the VHF comm output:

1. Press **MENU** twice. The Main Menu appears.
2. Highlight the **Setup** tab.
3. Use the **ROCKER** to select the **Interface** sub tab.
4. Highlight the **Serial Data Format** field and use the **ROCKER** to select **TIS In/NMEA & VHF Out** or **Aviation In/NMEA & VHF out**. These comm modes send both NMEA data and VHF frequency information.



The following features are now available on the radio:

- Remote frequency lists for departure, enroute, and arrival airports
- Nearest VOR frequencies (SL30 only)



**NOTE:** See your *SL30/40 User's Guide* regarding information on accessing remote frequency lists.

You can also use the GPSMAP 496 to directly tune a standby frequency in the radio by using the Comm tab when reviewing an airport.

### To select a standby comm frequency:

1. Use the map pointer or the **NRST** key to select an airport.
2. Highlight the **Comm** sub tab.
3. Select a comm frequency, and press **ENTER**. The frequency is now tuned in the standby slot on the radio.

If the comm frequency has a restriction, the restriction page has a **Tune** button, which performs the same function.

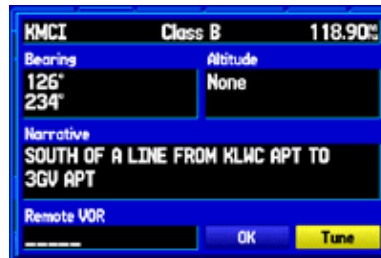

## Appendix

### Specifications

#### Physical Specifications

<b>Size:</b>	5.7" W x 3.2" H x 1.9" D (14.5 x 8.1 x 4.8 cm)
<b>Weight:</b>	14.2 oz (.40 kg)
<b>Display:</b>	3.75" diagonal (9.5 cm) Transflective, 256-color display with backlighting (480 x 320 pixels)
<b>Case:</b>	Fully gasketed, high-impact plastic alloy, waterproof to IEC 60529 IPX7
<b>Temp. Range:</b>	5°F to 140°F (-15°C to 60°C)
<b>Power</b>	
<b>Battery:</b>	Rechargeable lithium-ion
<b>Battery Life:</b>	4 to 15 hours based on the XM antenna and backlight usage
<b>Source:</b>	11–35 VDC
<b>Fuse:</b>	3AG-1.5 Amp

#### Performance

<b>Receiver:</b>	Differential-ready 12 parallel channel receiver
<b>Acquisition Times:</b>	Approx. 15 seconds (warm start) Approx. 45 seconds (cold start) Approx. 5 minutes (First Time/AutoLocate®)
<b>Update Rate:</b>	5/second, continuous
<b>Accuracy</b>	
<b>GPS:</b>	15 meters (49 feet) RMS 95% typical
<b>DGPS (USCG):</b>	3–5 meters (10–16 ft), 95% typical
<b>DGPS (WAAS):</b>	< 3 meters (10 ft) 95% typical with DGPS corrections
<b>Velocity:</b>	0.1 knot RMS steady state
<b>Dynamics:</b>	6 g's

## Care Information

Contact Garmin if you have any questions caring for your GPSMAP 496. In the USA contact Garmin Product Support by phone: (913) 397-8200 or (800) 800-1020, Monday–Friday, 8 AM–5 PM Central Time; or go to [www.garmin.com/support](http://www.garmin.com/support).

In Europe, contact Garmin (Europe) Ltd. at +44 (0) 870.8501241 (outside the UK) or 0808 2380000 (within the UK).

## Cleaning the Unit

The GPSMAP 496 is constructed of high quality materials and does not require user maintenance other than cleaning. Clean the unit using a cloth dampened with a mild detergent solution and then wipe dry. Avoid chemical cleaners and solvents that may damage plastic components.

## Storing the GPSMAP 496

Do not store the GPSMAP 496 where prolonged exposure to temperature extremes can occur (such as in the trunk of a car) as permanent damage may result. User information, such as waypoints and routes, is retained in the unit's memory without the need for external power. It is always a good practice to back up important user data by manually recording it or downloading it to a PC (transferring it to MapSource).

## Immersing the Unit in Water

The GPSMAP 496 is waterproof to IEC Standard 60529 IPX7. It can withstand immersion in 1 meter of water for 30 minutes. Prolonged submersion can cause damage to the unit. After submersion, be certain to wipe and air dry the unit before reuse or charging.

## Optional Accessories

In addition to the standard accessories included with your GPSMAP 496, the optional accessories are designed to enhance the operation of the GPSMAP 496.

To obtain replacement parts and optional accessories, contact your Garmin dealer, Garmin Product Support in the USA at 800/800.1020, or Garmin Europe at 44/0870.8501241.



---

**WARNING:** Garmin accessories have been designed and specifically tested for use with Garmin products. Accessories offered for sale by other manufacturers have not been tested or approved for use with Garmin products. Use of such accessories could cause damage to the GPSMAP 496 and void the warranty.

---

**PC Interface Cable**—Connects the unit to a serial port on your PC.

**Power/Data Cable**—Allows you to connect the unit to the electrical system using the bare wires.

**Programmable Data Cards**—Blank data cards available in a variety of sizes. Download detailed map data from MapSource CD-ROMs to a data card, either directly through your GPSMAP 496 using the included USB-PC Interface Cable, the optional PC Interface Cable (with a Serial connector), or with the optional USB Data Card Programmer.

**USB Data Card Programmer**—Programs blank data cards at high speed through a PC.

**Carrying Case**—Protects the GPSMAP 496 when not in use; with storage for data cards.

**Protective Cover**—Snaps on the front of the unit to protect the screen from damage.

**MapSource Software CD-ROMs**—Offers several detailed mapping options that are compatible with the GPSMAP 496, including BlueChart, Fishing Hot Spots, and Topo.

**Pre-Programmed Data Cards**—Data cards pre-programmed with either Garmin BlueChart or Fishing Hot Spots map data.

## Installation Information

### Connecting the Power/Data Cable

The power/data cable connects the GPSMAP 496 to an 11–35 VDC system and provides interface capabilities for connecting external devices. The color code in the diagram below and to the right indicates the appropriate harness connections. Replacement fuse is a 3AG - 1.5 Amp fuse.

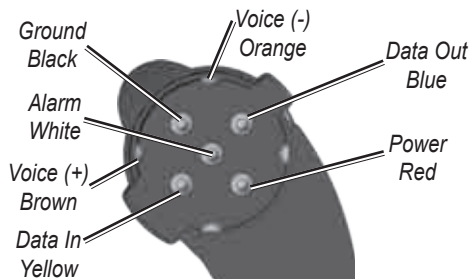

**Power/Data Connector on the GPSMAP 496 Unit**

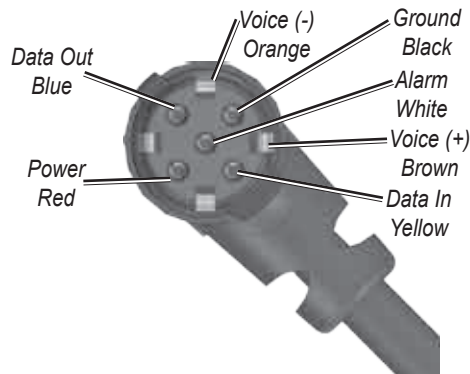

**Power/Data Connector on the Cable**

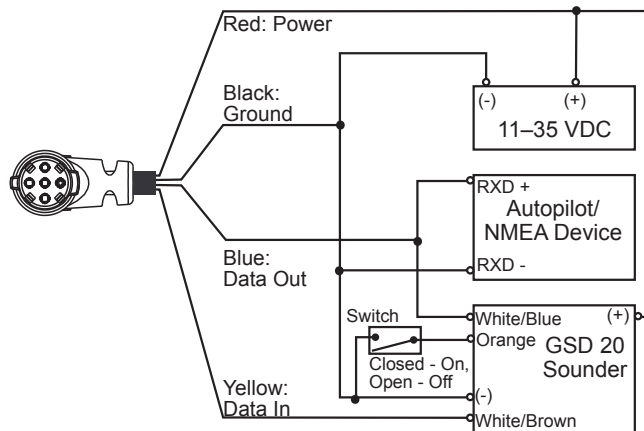

**NOTE:** The Alarm pin is used in Marine installations only.



**NOTE:** The Voice (+) and Voice (-) pins are intended for a speaker in automotive installations. Do not connect the Voice (+) and Voice (-) pins to an intercom or audio panel without first consulting the manufacturer.

## Connecting to a GTX 330 Mode S Transponder

To receive Mode S TIS traffic data from a GTX 330 transponder on your GPSMAP 496, connect an available RS-232 OUT pin on the transponder to the Data In pin on the GPSMAP 496. (You do not need to connect the transponder to the GPSMAP 496's Data Out pin.) Then, set the corresponding RS-232 output configuration on the transponder to **REMOTE + TIS** and set the GPSMAP 496's Serial Data Format to **TIS In** or **TIS In/NMEA & VHF Out**. For more information, see the TIS section on [page 147](#) and the *GTX 330 Transponder Installation Manual*.

## Connecting to a Garmin VHF Comm Radio

To output frequency data to an SL40 comm or SL30 nav/comm radio, connect the Data Out pin on the GPSMAP 496 to the Rx/D pin on the comm radio. (You do not need to connect the comm radio to the GPSMAP 496's Data In pin.) Set the GPSMAP 496's Serial Data Format to **TIS In/NMEA & VHF Out** or **Aviation In/NMEA & VHF Out**. For more information, see the VHF comm section on [page 154](#) and your nav/comm radio's installation manual.

## Connecting Your GPSMAP 496 to a Computer

Your GPSMAP 496 can be connected to your computer using the included USB-PC Interface Cable to connect to a USB data port or the optional PC Interface Cable to connect to a DB-9 serial communications port.



**NOTE:** Fully install the supplied MapSource program, Trip & Waypoint Manager, on your computer before connecting the USB cable to the computer.



USB  
connector  
under  
weather cap

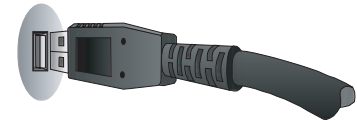

**USB Data Port on your PC**

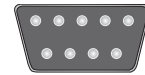

**Serial Communications Port**

### **To connect your GPS to your computer:**

1. Connect the small end of your cable to the lower connector on the back of the GPSMAP 496.
2. When using the supplied USB Data Cable, connect the larger end of the cable to an available USB data port.

When using a PC Interface Cable, connect the larger end of the cable to a serial communications port on your computer.

### **Information about USB Drivers**

The USB drivers should have been automatically installed when you installed the MapSource program that came with your GPSMAP 496. When you initially connect the GPSMAP 496 to a USB port, your computer prompts you to locate the destination of the drivers for the device. You only need to install the drivers once. After the drivers are installed, your computer always detects your GPSMAP 496 when it is connected. USB drivers are updated periodically. You can find these updates at [www.garmin.com](http://www.garmin.com).

### **Using xImage for Customized Waypoint Symbols**

xImage allows you to exchange images between your PC and your GPSMAP 496. You can download and save screen shots of any screen shown on your unit. xImage also allows you to download customizable splash screens and waypoint symbols from compatible GPS units, customize them (if you have an image editing program on your PC), and send them back to your GPS unit.

You can download xImage from the Garmin Web site at [www.garmin.com/ximage](http://www.garmin.com/ximage). Refer to the help file for complete instructions about using xImage.

### **Installing and Removing Data Cards**

The GPSMAP 496 uses an optional Garmin data card to show digital charts and maps. Install the data card in the slot located on the bottom of the unit. Install or remove the data card at any time, whether the unit is on or off.

You can load a variety of information on your data card, such as BlueChart and MapSource detailed maps in a MapSource program. You can buy pre-programmed cards to use with your GPSMAP 496.

Data cards are not waterproof, should not be exposed to moisture or excessive static charges, and should be stored in the case supplied with the card.

#### **To install a data card:**

1. Insert the card into the slot on the bottom of the unit. Be sure the label is facing the front of the unit.
2. Firmly push the card into the unit. It is not necessary to force the card. The handle is still exposed when it is properly inserted.



3. If the unit is on, a confirmation tone sounds. The first time you insert a programmed data card, the unit takes a few seconds to read the card. When the data card has been properly installed and accepted, a summary screen noting the card details appears. Press **ENTER** to acknowledge.

If you insert a data card and get a card format not recognized message, try removing the card and reinserting it. If the card is still not recognized, contact Garmin Product Support or your Garmin dealer.

#### To remove a data card:

1. Grasp the card handle. The handle expands for easy removal.
2. Pull the card out of the card slot on the bottom of the unit.
3. If the unit is on, a confirmation tone sounds when the data card is removed.

## Connecting the GXM 30A Antenna

Connect the GXM 30A antenna to the GPSMAP 496 to access XM WX satellite weather and XM Radio. For more information about the GXM 30A antenna, see the *GXM 30A Owner's Manual*.



**NOTE:** You must subscribe to XM Radio and/or XM WX Satellite Weather to use the XM Radio and/or XM Weather features on your GPSMAP 496.

#### To connect the GXM 30A antenna:

1. Position the antenna where it has a clear view of the sky. This can be on the outside of the vehicle or behind the windshield.
2. Plug the GXM 30A cable into the USB port on the back of the unit, as shown in the following illustrations.



**GXM 30A Antenna Plugged In**

## Interfacing

The following formats are supported for connection of external devices: GARMIN proprietary Differential GPS (DGPS), NMEA 0180, 0182, 0183 (versions 1.5, 2.0, 2.3, 3.01), ASCII Text Output, RTCM SC-104 input (version 2.0), and Garmin proprietary formats for connecting to a Mode S transponder for TIS data, and to a Garmin aviation NAV/COM radio.

The following are the Approved Sentences for NMEA 0183, version 3.01 output: GPRMC, GPGGA, GPGSA, GPGSV, GPGLL,

GPBOD, GPRTE, and GPWPL. The following are the Proprietary Sentences for NMEA 0183, version 3.01 output: PGRME, PGRMZ, PGRMM, and PGRMH.

The GPSMAP 496 also includes NMEA input with support for the BWC, DBT, DPT, MTW, VHW, VTG, and XTE sentences.

Garmin's proprietary communication protocol is available from the Web site ([www.garmin.com](http://www.garmin.com)).

## Removing the GPS Antenna

You can remove the antenna to use an external antenna. After the antenna is removed, the BNC connector is exposed and ready for use with an external antenna. For information on connecting an external antenna to the GPSMAP 496, refer to the installation instructions that came with the antenna.

### To remove the GPS antenna:

1. Remove the external power cable from the connector on the back of the GPSMAP 496.
2. Rotate the antenna to approximately a seven o'clock position. The alignment notches in the casing must line up with the notches on the antenna.
3. Pull the antenna away from the GPSMAP 496 unit.



**Removing the GPS Antenna**

## Learning About GPS

The Global Positioning System (GPS) is a satellite-based navigation system made up of a network of 24 satellites placed into orbit by the United States Department of Defense.

GPS was originally intended for military applications, but in the 1980s, the government made the system available for civilian use. GPS works in any weather conditions, anywhere in the world, 24 hours a day. There are no subscription fees or setup charges to use GPS. For more information refer to the Garmin Web site at [www.garmin.com](http://www.garmin.com) and also read the *GPS Guide for Beginners* at [www.garmin.com/aboutGPS/manual.html](http://www.garmin.com/aboutGPS/manual.html).

### Common GPS Terms

**Initialize**—the first time a GPS receiver orients itself to its current location and collects data. After the receiver is initialized, it remembers its location and acquires a location more quickly.

**Location**—an exact, unique location based on geographic coordinates (Latitude and Longitude).

**Route**—A group of waypoints entered into the GPS receiver in the sequence you want to navigate them.

**Waypoint**—a location you store in your GPS.

## What is Differential GPS (DGPS)?

The United States and Canadian governments (among others) have set up Differential GPS (DGPS) stations to transmit correction signals. They are operational in coastal areas and on many navigable river systems.

The DGPS system is available for use without a fee, but you do need additional equipment to receive DGPS signals: A beacon receiver compatible with the RTCM format sentences supported by your Garmin GPS is needed to use DGPS.

Refer to the United States Coast Guard's Web site ([www.navcen.uscg.gov](http://www.navcen.uscg.gov)) for locations and status of the differential stations.

### Differential Field

Differential receiver status is indicated in the bottom-left field of the GPS Page and shows one of the following conditions:

- **None**—no optional beacon receiver is attached or enabled on the Interface sub tab on the Main Menu or WAAS is turned off.
- **Searching for WAAS**—WAAS is enabled and the receiver is searching for WAAS signal.
- **Using WAAS**—WAAS capability is enabled and the unit is receiving WAAS corrections.

- **Check Beacon Wiring**—the DGPS setting is enabled in the Interface sub tab on the Main Menu but no DGPS device is detected.
- **No Beacon Signal**—DGPS receiver is attached, but not transmitting RTCM data to GPS.
- **Tuning Beacon**—the receiver is tuning manually to a DGPS frequency.
- **Using Differential**—the unit is receiving DGPS corrections.
- **Scanning for Beacon**—the DGPS receiver is scanning for an available frequency.

### What is WAAS/EGNOS?

The Wide Area Augmentation System (WAAS) is an FAA-funded service to improve the overall integrity of the GPS signal and increase position accuracy for users in North America. In Europe, WAAS is referred to as EGNOS.

The system is made up of satellites and approximately 25 ground reference stations positioned across the United States that monitor GPS satellite data. Two master stations, located on either coast, collect data from the reference stations and create a GPS data correction message.

According to the FAA's Web site, testing in September 2002, WAAS confirmed an accuracy performance of 1–2 meters horizontal and 2–3 meters vertical throughout the majority of the continental United States and portions of Alaska.

WAAS is just one service provider that adheres to the Minimum Operational Performance Standard (MOPS) for global Satellite Based Augmentation Systems (SBAS). Eventually, there will be several services of worldwide geostationary communication satellites and ground reference stations.

All SBAS systems use the same receiver frequency; therefore any operational SBAS system should be capable of providing your GPS unit with increased accuracy at any location in the world.

Currently, enabling WAAS on your Garmin GPSMAP 496 in regions that are not supported by ground stations may not improve accuracy, even when receiving signals from an SBAS satellite. In fact, it can degrade the accuracy to less than that provided by GPS satellites alone. For this reason, when you enable WAAS on your Garmin GPS receiver, the receiver automatically uses the method that achieves the best accuracy. To enable WAAS, refer to [page 4](#).

For more information, go to <http://gps.faa.gov/Programs/WAAS/waas.htm>.

## LORAN TD Setup

LORAN is a radio navigation aid operated and maintained in the United States by the United States Coast Guard. The name LORAN is an acronym for “LONg RANge Navigation”. The LORAN system covers the entire United States and the United States Coastal Confluence Zone. From the perspective of a mariner, the system is used for ocean and coastal navigation. It can be used as a supplemental system for harbor and harbor approach navigation, and it is used for inland navigation by recreational vehicles.

### LORAN TD Feature

The LORAN TD (Time Delay) feature eases the transition from using LORAN to using GPS. The GPSMAP 496 unit automatically converts GPS coordinates to LORAN TDs for those who have a collection of LORAN fixes for favorite fishing spots and other waypoints recorded as TDs. You can show your location as a TD or enter waypoints as TDs. The accuracy to be expected from this conversion is approximately thirty (30) meters. When the unit is placed in the LORAN TD format mode, it simulates the operation of a LORAN receiver. Location coordinates can be showed as TDs, and all navigation functions can be used as if the unit was actually receiving LORAN signals.

### Using the LORAN TD Format

When creating new waypoints using LORAN TD coordinates, you must set the correct LORAN chain number and secondary stations in the Setup TD field before storing the waypoint. After the waypoint is stored in unit memory, it always reference the LORAN chain number and secondary stations currently selected in the Setup TD field. If you enter a different LORAN chain number, or change the secondary stations or offsets in the Setup TD field, the active waypoint information does not reflect those changes. Since the GPSMAP 496 does not rely on the LORAN signal for navigation, it can reference a different GRI chain and/or secondary stations and still navigate to the location stored in memory.

The LORAN Location Format field is located under the Units sub tab in the Main Menu. The LORAN TD Setup window contains the fields to select the Loran GRI-Chain Number, Primary and Secondary Stations, and TD Offsets.

**To set up LORAN TD from the Main Menu:**

1. Press **MENU** twice to show the Main Menu.
2. Use the **ROCKER** to highlight Setup on the vertical tab list. Then select **Location** from the row of horizontal tabs.
3. Using the **ROCKER**, highlight the **Location Format** field and press **ENTER**.

**Location Sub Tab**

4. Highlight **Loran TD**, and press **ENTER**.
5. Highlight the **Setup** button located on the right side of the **Location Format** field, and press **ENTER**. The Loran TD Setup window appears.
6. To change the settings of any of the five fields, highlight the field, press **ENTER**, enter the setting using the **ROCKER**, and press **ENTER**.
7. When finished, highlight the **Save** button, and press **ENTER**.

**LORAN TD Setup**

If the active GRI Chain, secondary stations, or offsets were changed since the waypoint was created, the waypoint now references the active GRI chain and secondary stations and adjust the TD coordinates accordingly. Remember that the GPS is not relying on the LORAN signal for navigation and actually converts the TD coordinate to a useful latitude and longitude coordinate before storing the waypoint to memory or using it for navigation. Because of this, the unit can navigate to a TD coordinate anywhere in the world.

You must know your GRI chain number and/or secondary stations to create a LORAN TD location. For more information read our *LORAN TD Position Format Handbook*, available at the Garmin Web site, at [www.garmin.com/support/userManual.jsp](http://www.garmin.com/support/userManual.jsp).

## Map Datums and Location Formats

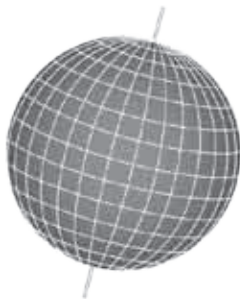

*Map Datums are based on a mathematical model of the Earth.*

### What are Map Datums?

A datum is a mathematical model of the Earth that approximates the shape of the Earth and enables calculations to be carried out in a consistent and accurate manner. The datum is physically represented by a framework of ground monuments (such as trig. stations) whose locations have been accurately measured and calculated on this reference surface. Lines of latitude and longitude on a map or chart are referenced to a specific map datum. Every chart has a map datum reference and the GPSMAP 496 can be set to match most of those commonly used.

If you are navigating and comparing the GPS coordinates to a map, chart, or other reference, the map datum in the GPS unit should be set to the same datum as the map to ensure the most accurate navigation.

### What is a Location Format?

Your current location can be viewed on the GPS in the form of coordinates. Since different maps and charts use different location formats, Garmin GPS units allow you to choose the correct coordinate system for the type of map you are using. The most common format is latitude and longitude, which is used by all Garmin units. You can change the location format to use with other coordinate systems in Location Preferences. UTM/UPS (Universal Transverse Mercator/Universal Polar Stereographic) are easy-to-use metric grids that are found on most USGS topographic quadrangle maps. Several other grids, including a user-definable grid (for the advanced user), are available.

For more information about using paper maps with your Garmin unit, refer to *Using a Garmin GPS with Paper Land Maps*, available for download at [www.garmin.com/manuals/UsingaGarminGPSwithPaperLandMaps\\_Manual.pdf](http://www.garmin.com/manuals/UsingaGarminGPSwithPaperLandMaps_Manual.pdf).

## Digital Selective Calling (DSC)

Digital Selective Calling (DSC) uses marine VHF radio and Global Positioning System (GPS) technologies to transmit and receive location information. DSC is used by mariners to assist them in two major areas: Distress Calls and Position Reporting.

A non-emergency DSC Position Report allows mariners to exchange and show the locations of one another. When you receive a DSC location, you can create a waypoint or to show the received location on an electronic map.

An emergency DSC Distress Call allows a vessel in trouble to transmit a substantial amount of information in a single transmission or “call,” without the need for voice communication. When any nearby rescuer receives the DSC signal, an alarm sounds and they immediately receive the location of the caller.

The rescuer can choose to navigate (Go To) the caller’s location to assist or forward the call on to the Coast Guard. When the Coast Guard receives the call, they can immediately access the caller’s information (such as who they are and the type of vessel) in their database while they are in transit to the caller’s location.

Any time a vessel receives a DSC call, they can store that location and quickly navigate to that location using a Go To. This makes DSC a time-saver, especially in an emergency situation. In order to use DSC, users must first register their VHF radio with the FCC and receive a Maritime Mobile Service Identity (MMSI) number.

### What is a Maritime Mobile Service Identity (MMSI)?

Maritime Mobile Service Identity (MMSI) basically allows a VHF radio to act like a phone. The 9-digit MMSI number acts like a phone number when used in a Position Report and as a unique identifier to the Coast Guard when used in an emergency Distress Call. To obtain a Maritime Mobile Service Identity (MMSI) number, users must register their VHF radio with the FCC (Form 605).

**Garmin does not supply this number!**

For more information regarding MMSI’s visit [www.navcen.uscg.gov/marcomms/gmdss/mmsi.htm](http://www.navcen.uscg.gov/marcomms/gmdss/mmsi.htm).



## How Are MMSI Assignments Obtained?

Non-commercial users, such as recreational users, who remain in United States waters and only carry VHF, EPIRB (Emergency Position Indicating Radio Beacons), and Radar are not required to have a FCC ship station license. The FCC and Coast Guard have authorized some second and third party vendors to assign MMSI numbers. This service is limited to registering recreational vessels only. To receive information on how to obtain a recreational MMSI number go to [www.uscg.mil](http://www.uscg.mil).

### United States Non-Federal User

Commercial users, or those who travel outside the United States or Canada, must apply for a ship station license or an amendment to a ship station license. To find out if you require a Ship Station license contact <http://wireless.fcc.gov/marine/fctsh14.html>. If your vessel requires licensing by the FCC, a MMSI is assigned to you during the application/licensing process when you file FCC Forms 159 and 605.

### United States Federal User

Federal users can obtain MMSI assignments from their agency radio spectrum management office. These procedures are currently under review by the National Telecommunications and Information Administration (NTIA).

## User Outside the United States

Users can obtain an MMSI assignment from their telecommunications authority or ship registry, often by obtaining or amending their ship station license.

### User In Canada

Industry Canada is responsible for assigning MMSI numbers to commercial and recreational vessels. Information is available at <http://sd.ic.gc.ca/engdoc/mmsi.jsp>.

## How Can Garmin Help You with DSC?

To receive Distress Calls or Position Reports, you must have a DSC-equipped chartplotter as well as a VHF radio with DSC support. During normal, non-emergency Position Report communication, Channel 70 (156.525 MHz) has been set aside as the VHF/DSC digital call channel.

For a Distress Call, press the MayDay button on the VHF radio. The call transmits on an emergency channel with the MMSI number attached to the call, if the receiver has DSC support. Any DSC-equipped mariner (on sea or land) within range can receive the call.

When the Garmin GPSMAP 496 is connected to a VHF with DSC support, the GPS unit shows a Call List, Log, and a Directory. Basic wiring is required for the Garmin unit and VHF radio to send and receive NMEA data from each other.

## Jeppesen Database Information

The GPSMAP 496 includes an internal Jeppesen® database that provides location and facility information for thousands of airports, VORs, NDBs, and more. Updates to the Jeppesen database are available every 28 days online ([www.garmin.com](http://www.garmin.com)). The update program is designed to operate on Windows®-compatible PCs and requires the included USB cable to connect your GPSMAP 496 to the PC's USB port. The following information is provided from the internal Jeppesen database:

**Airport**—\* identifier, facility name, city/state/country, latitude/longitude, field elevation, available fuel types, runway designations and layout, runway surface, runway length, runway width, runway lighting, communication frequencies, and published approaches.

**Weather**—frequencies associated with an airport (ASOS, ATIS, and AWOS).

**VORs**—\* identifier, facility name, city/state/country, location (latitude/longitude), frequency, service volume (high, low, terminal), and type (such as VOR-DME, TACAN, and VORTAC).

**NDBs**—\* identifier, facility name, city/state/country, location (latitude/longitude), and frequency.

**Intersections**—identifier, nearest VOR, radial and distance from nearest VOR, location (latitude/longitude), and region/country.

**ARTCC**—Air Route Traffic Control Centers.

**Airspace**—boundaries (Class B, Class C, Control Zones, SUAs, and MOAs), controlling agency, and vertical boundaries.

**FSS**—Flight Service Stations.

\* Symbology used for NDBs, VORs, and airports is consistent with those used on a sectional chart.

## Database Updates

Updates to the Jeppesen database are available every 28 days online (<http://shop.garmin.com/aviation/databases>). The update programs are designed to operate on Windows®-compatible PCs and requires the included USB Interface Cable to be connected to the unit and an available USB port on your computer.



---

**NOTE:** After you perform an update to your Jeppesen database, verify that all of your flight plans (routes) in your unit are current. If there is an obsolete Jeppesen aviation point in a saved route, the route is locked and unusable. You need to create a new route with current Jeppesen database points.

---

An optional FlightBook software package is available to assist with your flight record keeping. Visit the Garmin Web site at [www.garmin.com/aviation](http://www.garmin.com/aviation).

## Messages

**Accuracy Alarm**—the GPS accuracy has fallen outside of user-set value.

**Alarm Clock**—the alarm clock has sounded.

**Antenna Shorted to Ground**—the external GPS antenna has an electrical connection problem. Contact Garmin Product Support.

**Approaching Target Altitude**—within 1,000 feet of final VNAV target altitude.

**Approaching Turn**—you are nearing a turn in a route.

**Approaching VNAV Profile**—you are within one minute of reaching the initial VNAV decent point.

**Arriving at Destination**—you are nearing your destination.

**Batteries Low**—the battery needs to be recharged.

**Basemap Failed Unit Needs Repair**—there is an internal problem with your unit. Contact Garmin Product Support to have the unit serviced.

**Boat Is Not Moving Fast Enough to Calibrate**—the boat is not moving fast enough for the speed wheel to provide a valid speed.

**Can't Unlock Maps**—no applicable unlock code for one or more maps was found. All MapSource maps are not accessible.

**Check XM Antenna**—internal problem with your GXM 30A antenna. Contact Garmin Product Support.

**Database Error**—internal problem with the unit. Contact your dealer or Garmin Product Support to have the unit repaired.

**Deep Water**—the water is deeper than the amount set in the Deep Water Alarm.

**Detail Maps Don't Support Routing**—maps that are loaded on the data card do not support automatic route calculation.

**Distress Call**—a DSC distress call was received. Take appropriate action.

**Dragging Anchor**—the distance set in the Anchor Drag Alarm is exceeded.

**Drift Alarm**—the water depth has changed by the amount entered in the Drift Alarm setup.

**Fish Alarm**—a fish was detected. The unit shows an icon and beeps (if enabled). This alarm does not show a message banner.

**Flash Flood Warning**—a flash flood warning was issued for the area by the National Weather Service.

**Flood Warning**—a flood warning was issued for the area by the National Weather Service.

**Lost Satellite Reception**—the unit is unable to receive satellite signals.

**Marine Warning**—a marine warning was issued by the National Weather Service.

**Memory Full**—unit memory is full, no further data can be saved.

**Memory (RAM) Failed Unit Needs Repair**—there is an internal problem with your unit. Contact Garmin Product Support to have the unit serviced.

**Near Proximity Point**—you have reached the distance set for a proximity waypoint.

**NMEA Depth is Below Transducer**—no keel offset value has been received from the external sonar device.

**No Diff GPS Location**—RTCM is selected but the unit is not receiving DGPS data.

**No Roads Near Destination**—the destination for the road route you tried to calculate is not near any roads. Select a different destination.

**No Roads Near Starting Point**—the start location for the road route you tried to calculate is not near any roads. Select a different start location.

**No DGPS Position**—no differential connection data is available, or

not enough data is available to calculate a DGPS position.

**No Tide Stations for that Area**—no tide stations within 100 miles of the area.

**No XM Signal**—the GXM 30A antenna is not receiving an XM signal.

**None Found**—no data matched the search criteria.

**Off Course**—you are off course by the distance set in the Off Course Alarm.

**Proximity Memory Full**—no additional proximity waypoints can be saved.

**Proximity Radius Overlaps**—the radius of two proximity waypoints overlap.

**Route Already Exists**—you have entered a route name that already exists.

**Route Calculation Error**—no route can be calculated.

**Route Memory Full**—no additional routes can be saved.

**Route Truncated**—uploaded route from another device has more than 300 waypoints.

**Route Waypoint Memory Full**—no additional route waypoints can

be saved.

**Saving XM Program Information**—an XM Radio channel lineup change has occurred and the unit is saving the channel lineup to memory.

**Shallow Water**—the water is shallower than the amount set in the Shallow Water Alarm.

**Sonar Failed Unit Needs Repair**—there is an internal problem with the unit. Contact Garmin Product Support to have the unit serviced.

**Steep Turn**—approaching a turn that requires a bank angle in excess of 25 degrees to stay on course.

**Sunrise, Switching to Day Mode**—the unit is switching to Day Mode.

**Sunset, Switching to Night Mode**—the unit is switching to Night Mode

**Thunderstorm Warning**—a severe thunderstorm warning was issued for the area by the National Weather Service.

**Tornado Warning**—a tornado warning was issued for the area by the National Weather Service.

**Track Already Exists**—a saved track with the same name already exists.

**Track Log Full**—the track log is full and track recording was turned off. To record more track points, you need to clear the track log and turn track recording on.

**Track Memory Full**—no more track data can be stored. Delete the old track data to store the new data.

**Track Truncated**—a complete uploaded track will not fit in memory. The oldest track log points have been deleted.

**Transducer Disconnected, Sonar Turned Off**—the unit has no transducer attached, has a bad cable/transducer, or has a disconnected transducer cable.

**Transfer Complete**—data transfer was completed.

**USB Connected**—the USB cable was recently plugged in.

**User Timer Expired**—the Timer Alarm value has counted down to zero.

**VNAV Cancelled**—VNAV function has been cancelled due to a change in the active route.

**Water Speed Sensor is Not Working**—the speed sensor is not detected. Check the connections.

**Water Temperature Alarm**—sonar has reported a temperature above, below, inside, or outside the specified values(s).

**Waypoint Already Exists**—a waypoint with the same name already exists.

**Waypoint Memory Full**—the unit has stored the maximum number of waypoints.

**XM Antenna Not Responding**—the unit is unable to communicate with the GXM 30A.

**XM Connected**—the GXM 30A antenna was recently plugged in.

## Data Field Options

The following list provides a brief description of each data field option. Some of these options are supported only by devices interfaced to your GPSMAP 496.

**Accuracy**—the current accuracy of your GPS determined location.

**Battery Timer**—the time remaining on the battery before it is fully discharged.

**Bearing**—the compass direction from your current location to a destination.

**Course**—the your path of travel from your starting location to a destination.

**Course to Steer**—the recommended direction to steer in order to reduce cross-track error and return to the course line. Shown as

**Steer.**

**Cross Track**—the distance you are off your course in either direction, left or right.

**Depth (Marine Only)**—the depth of water from sonar NMEA input.

**Dest Wpt**—see **Waypoint (Destination)**.

**Distance (Destination)**—the entire distance, from beginning to end, of a route.

**Distance (Next)**—the distance to the next point on a route.

**ETA (Destination)**—Estimated Time of Arrival. The estimated time you will reach your destination.

**ETA (Next)**—Estimated Time of Arrival. The estimated time you will reach the next point on your route.

**ETE (Destination)**—Estimated Time Enroute. The estimated time required to reach your destination.

**ETE (Next)**—Estimated Time Enroute. The estimated time required to reach the next point on your route.

**Elevation**—the altitude (height) above or below mean sea level (MSL).

**GPS Status**—the current status of the GPS receiver, such as “3D

GPS.”

**Location (Lat/Lon)**—your current location as latitude/longitude coordinates.

**Location (Selected)**—your current location described in the selected units of measure (other than lat/lon).

**Max Speed**—the maximum speed the unit has moved since last reset.

**Mov Avg Spd**—see **Trip Avg. Speed (Moving)**.

**Move Timer**—see **Trip Timer (Moving)**.

**Next Course**—the course your route will take you on after you reach the next waypoint.

**Next Turn**—the direction of the next turn on an active route.

**Next Wpt**—see **Waypoint (Next)**.

**Odometer**—the total distance traveled since the Odometer was reset.

**Pointer**—the arrow indicating the direction to travel to the next point on a route.

**Power**—the power indicator icon: Battery, External Power, or Charging.

**Speed**—your current vehicle speed can be measured in miles per hour, kilometers per hour, or knots.

**Steer**—see **Course to Steer**.

**Sunrise**—the time at which the sun rises on this day.

**Sunset**—the time at which the sun sets on this day.

**Time**—the current time and date. It can be shown in 12-hour or 24-hour format in local time or universal (UTC) time.

**Track**—the direction of movement relative to a ground position. Also referred to as ground track.

**Trip Avg. Speed (Moving)**—the average speed while moving since the last reset of the Trip Computer. Appears as **Mov Avg Spd**.

**Trip Avg. Speed (Total)**—the total average speed traveled since the last reset of the Trip Computer. Shown as **Ttl Avg Spd**.

**Trip Odometer**—the total distance traveled since the Trip Computer was reset.

**Trip Timer (Moving)**—the length of time your vehicle has been in motion, since the Trip Computer was reset. Appears as **Move Timer**.

**Trip Timer (Total)**—the total time the unit has been tracking since the Trip Computer was reset.

**Ttl Avg Spd**—see **Trip Avg. Speed (Total)**.

**Turn**—the distance between Bearing (BRG) and Track (TRG). L indicates you should turn left. R indicates you should turn right. The degrees indicates the difference angle and the number of degrees you should turn.

**User Timer**—the timer you set in the Main Menu.

**Velocity Made Good**—the rate of closure on a destination based on your current speed and course of travel. Shown as **VMG**.

**Vertical Speed**—the rate of climb or descent.

**Voltage**—the direct current voltage level of an external power source.

**Water Speed (Marine Only)**—the data acquired from measurement devices interfaced to the unit is used to calculate your current speed over water.

**Water Temperature (Marine Only)**—the temperature of water at a measured depth using measurement devices interfaced to the unit.

**Waypoint (Destination)**—the last point on a route, your destination. Appears as **Dest Wpt**.

**Waypoint (Next)**—the next waypoint in your route. Shown as **Next Wpt**.

**Weather–Altimeter**—the altimeter setting at the nearest METAR reporting station.

**Weather–Dew Point**—the dew point at the nearest weather reporting station.

**Weather–Pressure**—the surface pressure at the nearest weather reporting station.

**Weather–Relative Humidity**—the relative humidity at the nearest weather reporting station.

**Weather–Temperature**—the temperature at the nearest weather reporting station.

**Weather–Wind**—the wind speed and direction at the nearest weather reporting station.

**XM Audio**—the artist and song title of the XM audio channel currently playing.

**XM Signal**—the strength of the XM signal.



## License Agreement and Warranty

This section contains information about your license agreement and warranty for the GPSMAP 496.

### Software License Agreement

BY USING THE GPSMAP 496, YOU AGREE TO BE BOUND BY THE TERMS AND CONDITIONS OF THE FOLLOWING SOFTWARE LICENSE AGREEMENT. PLEASE READ THIS AGREEMENT CAREFULLY.

Garmin grants you a limited license to use the software embedded in this device (the “Software”) in binary executable form in the normal operation of the product. Title, ownership rights, and intellectual property rights in and to the Software remain with Garmin.

You acknowledge that the Software is the property of Garmin and is protected under the United States of America copyright laws and international copyright treaties. You further acknowledge that the structure, organization, and code of the Software are valuable trade secrets of Garmin and that the Software in source code form remains a valuable trade secret of Garmin. You agree not to decompile, disassemble, modify, reverse assemble, reverse engineer, or reduce to human readable form the Software or any part thereof or create any derivative works based on the Software. You agree not to export or re-export the Software to any country in violation of the export control laws of the United States of America.

### Product Registration

Help us better support you by completing our online registration today! Connect to our Web site at <http://my.garmin.com>. Keep the original sales receipt, or a photocopy, in a safe place.

### Contact Garmin

Contact Garmin if you have any questions while using your GPSMAP 496. In the USA contact Garmin Product Support by phone: (913) 397-8200 or (800) 800-1020, Monday–Friday, 8 AM–5 PM Central Time; or go to [www.garmin.com/support](http://www.garmin.com/support).

In Europe, contact Garmin (Europe) Ltd. at +44 (0) 870.8501241 (outside the UK) or 0808 2380000 (within the UK).

### Limited Warranty

This Garmin product is warranted to be free from defects in materials or workmanship for one year from the date of purchase. Within this period, Garmin will, at its sole option, repair or replace any components that fail in normal use. Such repairs or replacement will be made at no charge to the customer for parts or labor, provided that the customer shall be responsible for any transportation cost. This warranty does not cover failures due to abuse, misuse, accident, or unauthorized alteration or repairs.

This product is intended to be used only as a travel aid and must not be used for any purpose requiring precise measurement of direction, distance, location, or topography. Garmin makes no warranty as to the accuracy or completeness of map data in this product.

THE WARRANTIES AND REMEDIES CONTAINED HEREIN ARE EXCLUSIVE AND IN LIEU OF ALL OTHER WARRANTIES EXPRESS, IMPLIED, OR STATUTORY, INCLUDING ANY LIABILITY ARISING UNDER ANY WARRANTY OF MERCHANTABILITY OR FITNESS FOR A PARTICULAR PURPOSE, STATUTORY OR OTHERWISE. THIS WARRANTY GIVES YOU SPECIFIC LEGAL RIGHTS, WHICH MAY VARY FROM STATE TO STATE.

IN NO EVENT SHALL GARMIN BE LIABLE FOR ANY INCIDENTAL, SPECIAL, INDIRECT, OR CONSEQUENTIAL DAMAGES, WHETHER RESULTING FROM THE USE, MISUSE, OR INABILITY TO USE THIS PRODUCT OR FROM DEFECTS IN THE PRODUCT. SOME STATES DO NOT ALLOW THE EXCLUSION OF INCIDENTAL OR CONSEQUENTIAL DAMAGES, SO THE ABOVE LIMITATIONS MAY NOT APPLY TO YOU.

Garmin retains the exclusive right to repair or replace the unit or software or offer a full refund of the purchase price at its sole discretion. SUCH REMEDY SHALL BE YOUR SOLE AND EXCLUSIVE REMEDY FOR ANY BREACH OF WARRANTY.

To obtain warranty service, contact your local Garmin authorized dealer or call Garmin Product Support for shipping instructions and an RMA tracking number. Securely pack the unit and a copy of the original sales receipt, which is required as the proof of purchase for warranty repairs. Write the tracking number clearly on the outside of the package. Send the unit, freight charges prepaid, to any Garmin warranty service station.

**Online Auction Purchases:** Products sold through online auctions are not eligible for rebates or other special offers from Garmin. Online auction confirmations are not accepted for warranty verification. To obtain warranty service, an original or copy of the sales receipt from the original retailer is required. Garmin will not replace missing components from any package purchased through an online auction.

**International Purchases:** A separate warranty is provided by international distributors for units purchased outside the United States. This warranty is provided by the local in-country distributor and this distributor provides local service for your unit. Distributor warranties are only valid in the area of intended distribution. Units purchased in the United States or Canada must be returned to the Garmin service center in the United Kingdom, the United States, Canada, or Taiwan for service.

## **AOPA Airport Directory Notice**

AOPA MEMBERSHIP PUBLICATIONS, INC. AND ITS RELATED ORGANIZATIONS (HEREINAFTER COLLECTIVELY “AOPA”) EXPRESSLY DISCLAIM ALL WARRANTIES, WITH RESPECT TO THE AOPA INFORMATION INCLUDED IN THIS DATA, EXPRESS OR IMPLIED, INCLUDING, BUT NOT LIMITED TO, THE IMPLIED WARRANTIES OF MERCHANTABILITY AND FITNESS FOR A PARTICULAR PURPOSE. THE INFORMATION IS PROVIDED “AS IS” AND AOPA DOES NOT WARRANT OR MAKE ANY REPRESENTATIONS REGARDING ITS ACCURACY, RELIABILITY, OR OTHERWISE. UNDER NO CIRCUMSTANCES INCLUDING NEGLIGENCE, SHALL AOPA BE LIABLE FOR ANY INCIDENTAL, SPECIAL OR CONSEQUENTIAL DAMAGES THAT RESULT FROM THE USE OR INABILITY TO USE THE SOFTWARE OR RELATED DOCUMENTATION, EVEN IF AOPA OR AN AOPA AUTHORIZED REPRESENTATIVE HAS BEEN ADVISED OF THE POSSIBILITY OF SUCH DAMAGES. USER AGREES NOT TO SUE AOPA AND, TO THE MAXIMUM EXTENT ALLOWED BY LAW, TO RELEASE AND HOLD HARMLESS AOPA FROM ANY CAUSES OF ACTION, CLAIMS OR LOSSES RELATED TO ANY ACTUAL OR ALLEGED INACCURACIES IN THE INFORMATION ARISING OUT OF GARMIN’S USE OF THE INFORMATION IN THE DATASETS. SOME JURISDICTIONS DO NOT ALLOW THE LIMITATION OR EXCLUSION OF IMPLIED WARRANTIES OR LIABILITY FOR INCIDENTAL OR CONSEQUENTIAL DAMAGES SO THE ABOVE LIMITATIONS OR EXCLUSIONS MAY NOT APPLY TO YOU.

## **Weather Data Warranty**

THE WEATHER DATA SOFTWARE PRODUCT IS PROVIDED “AS IS.” ALL OTHER WARRANTIES, EXPRESSED OR IMPLIED, INCLUDING ANY WARRANTY OF MERCHANTABILITY OR FITNESS FOR A PARTICULAR PURPOSE OR OF NON-INFRINGEMENT ARE HEREBY EXCLUDED.

**USER SAFETY**

If you use XM Services it is your responsibility to exercise prudent discretion and observe all safety measures required by law and your own common sense. You assume the entire risk related to your use of the Services. XM and Garmin assume no responsibility for accidents resulting from or associated with use of the Services. Your Radio Service includes traffic and weather information, and you acknowledge that such information is not for “safety for life”, but is merely supplemental and advisory in nature, and therefore cannot be relied upon as safety-critical in connection with any aircraft, sea craft or automobile usage. This information is provided “as is” and XM and Garmin disclaim any and all warranties, express and implied, with respect thereto or the transmission or reception thereof. XM and Garmin further do not warrant the accuracy, reliability, completeness or timeliness of the traffic and weather information disclosed on the Radio Service. In no event will XM and Garmin, their data suppliers, service providers, marketing/distribution, software or Internet partners or hardware manufacturers be liable to you or to any third party for any direct, indirect, incidental, consequential, special, exemplary or punitive damages or lost profits resulting from use of or interruptions in the transmission or reception of the Services.

**LIMITS ON OUR RESPONSIBILITY****a) DISCLAIMERS.**

EXCEPT AS EXPRESSLY PROVIDED HEREIN, WE MAKE NO WARRANTY OR REPRESENTATION, EITHER EXPRESS OR IMPLIED, REGARDING THE RADIO SERVICE. YOUR USE OF THE SERVICE IS AT YOUR SOLE RISK. THE CONTENT AND FUNCTIONALITY OF THE SERVICE IS PROVIDED “AS IS” WITHOUT ANY WARRANTY OF ANY KIND, EXPRESS OR IMPLIED. ALL SUCH WARRANTIES OR REPRESENTATIONS (INCLUDING, WITHOUT LIMITATION, THE IMPLIED WARRANTIES OF MERCHANTABILITY, FITNESS FOR A PARTICULAR PURPOSE, TITLE AND NON-INFRINGEMENT) ARE HEREBY DISCLAIMED.

**b) LIMITATIONS OF LIABILITY.**

WE ARE NOT RESPONSIBLE FOR ANY SPECIAL, INCIDENTAL, OR CONSEQUENTIAL DAMAGES OR LOSSES RELATING TO THE USE OF THE RADIO SERVICE, WHETHER BASED ON NEGLIGENCE OR OTHERWISE. OUR TOTAL LIABILITY TO YOU AND ANY OTHER PERSONS RECEIVING OUR SERVICES, REGARDLESS OF THE CAUSE, WILL IN NO EVENT EXCEED THE AMOUNTS THAT YOU HAVE PAID TO US FOR THE SERVICE THAT YOU RECEIVED DURING THE SIX (6) MONTH PERIOD IMMEDIATELY PRIOR TO THE SPECIFIC EVENT THAT GAVE RISE TO THE APPLICABLE DAMAGE OR LOSS. THIS ALLOCATION OF RISK IS REFLECTED IN OUR PRICES. YOU MAY HAVE GREATER RIGHTS THAN DESCRIBED ABOVE UNDER YOUR STATE’S LAWS

This product was developed using DAFIF™, a product of the National Geospatial-Intelligence Agency.

This product has not been endorsed or otherwise approved by the National Geospatial-Intelligence Agency, or the United States Department of Defense (10 U.S.C. 425)

a. Under 10 U.S.C. 456, no civil action may be brought against the United States on the basis of the content of a navigational aid prepared or disseminated by either the former Defense Mapping Agency (DMA), National Imagery and Mapping Agency (NIMA), or the National Geospatial-Intelligence Agency (NGA).

b. The DAFIF™ product is provided “as is,” and no warranty, express or implied, including, but not limited to the implied warranties of merchantability and fitness for particular purpose or arising by statute or otherwise in law or from a course of dealing or usage in trade, is made by NGA as to the accuracy and functioning of the product.

c. Neither NGA nor its personnel will be liable for any claims, losses, or damages arising from or connected with the use of this product. The user agrees to hold harmless the United States National Geospatial-Intelligence Agency. The user’s sole

and exclusive remedy is to stop using the DAFIF product.

## **XM Satellite Radio Service Agreement**

XM Satellite Radio Inc.

Hardware and required monthly subscription sold separately. Subscription fee is consumer only. Other fees and taxes, including a one-time activation fee may apply. All programming fees and weather data subject to change. XM WX weather data displays and individual product availability vary by hardware equipment. Reception of the XM signal may vary depending on location. Subscriptions subject to Customer Agreement included with the XM Welcome Kit and available at xmradio.com. Available only in the 48 contiguous United States. XM WX is a trademark of XM Satellite Radio Inc.

Contact XM Satellite Radio by phone at 800.985.9200 to subscribe to XM WX Weather and/or XM Radio.

## **FCC Compliance**

This device complies with part 15 of the FCC Rules. Operation is subject to the following two conditions: (1) this device may not cause harmful interference, and (2) this device must accept any interference received, including interference that may cause undesired operation.

This equipment has been tested and found to comply with the limits for a Class B digital device, pursuant to part 15 of the FCC rules. These limits are designed to provide reasonable protection against harmful interference in a residential installation. This equipment generates, uses, and can radiate radio frequency energy and may cause harmful interference to radio communications if not installed and used in accordance with the instructions. However, there is no guarantee that interference will not occur in a particular installation. If this equipment does cause harmful interference to radio or television reception, which can be determined by turning the equipment off and on, the user is encouraged to try to correct the

interference by one of the following measures:

- Reorient or relocate the receiving antenna.
- Increase the separation between the equipment and the receiver.
- Connect the equipment into an outlet that is on a different circuit from the GPS unit.
- Consult the dealer or an experienced radio/TV technician for help.

This product does not contain any user-serviceable parts. Repairs should only be made by an authorized Garmin service center. Unauthorized repairs or modifications could result in permanent damage to the equipment, and void your warranty and your authority to operate this device under Part 15 regulations.

## **Industry Canada Compliance**

Category I radiocommunication devices comply with Industry Canada Standard RSS-210. Category II radiocommunication devices comply with Industry Canada Standard RSS-310.

# Index

## Symbols

2D 5, 63, 143

3D 5, 63

## A

accessories 157

acquiring satellites 5

Active Route page

aviation mode 44

Active Track tab 87, 90

add to route 61, 68, 76, 80

advanced NMEA output setup 124

aircraft information 47–48

airport 18, 170

criteria 22

identifier 6, 12, 14

information 15, 16, 19

airspace 32

alarms 106

alert 21, 28

boundary 29, 32

information 20, 21, 32

nearest 18

alarms 28, 115

airspace 106

anchor drag 107

arrival 107

depth 108

descent rate 37, 38

DSC 100

fish 108

next turn 106

obstacle 37, 38

off course 107

persistent 106

proximity 86

sonar 108

system 107

terrain 37, 38

terrain page setup 39

VNAV 42

Alarms tab

airspace alarms 106

navigation 106

system alarms 107

alerts. *See* alarms

altitude 40, 119

antenna 1, 3, 162

append to route 80

approach 16, 23, 24, 44

ARTCC 18

assign category 83

asterisk (\*) 16

audio connector 1

AutoLocate 3, 5

average location 80

avoids 67, 117

## B

backlight 3, 114

baro pressure 50

battery

level 4

pack 1, 2

saver mode 116

beeper 115

BlueChart 160

bug indicator 41, 94

setting 34

## C

cable 158

calculate routes for 117

calculation method 117

calendar 109–112

calibrated airspeed 50

calibrate water speed 141

cards, data 160

care information 157

categories

find menu 58

waypoint 82

CDI. *See* course deviation indicator

celestial information 109–112

Celestial tab

Hunt & Fish tab 112

Sun & Moon tab 109

Tide tab 110

charging 2, 4

check beacon wiring 164

cigarette lighter adapter 2

cleaning 156

clear track log 88

clock alarm 107

coast guard 168, 169

color mode 114

communication frequencies 20

comm usage restrictions 16

compass page 55, 95, 114

marine mode 94–95

options menu 94

connecting the power cable 2, 158

course deviation indicator 24, 40,  
41, 94

course deviation scale 40, 41

course pointer 94

course to steer 34

create

category 82

flight plan 27

route 61, 62

waypoint. *See* marking a waypoint

creating a direct to 14–16

criteria 22

cruising speed 47

Current Route page 66

automotive mode 72

custom avoids 67, 117

**D**

dashboard 73  
data card 160  
    slot 1  
data fields 35  
date 119  
daylight saving time 119  
DB-9 159  
declutter 33  
defaults 8, 35  
delete  
    aircraft profile 48  
    category 82  
    DSC directory item 99  
    flight records 46  
    route 74  
    track log 88  
    waypoint 85  
    waypoint category 82  
density altitude 50  
depth 119  
descent rate alert 28  
detailed maps 10, 36, 160  
details 15, 16, 19  
detour 68  
DGPS 124, 163  
    alarm 107  
differential 164  
differential field 163  
differential GPS 163

digital selective calling. *See* DSC  
direction display 119  
Direct To 14, 19  
display tab 114  
distance and speed 119  
distress calls 97–100, 168–169  
drift alarm 108  
DSC 96–100, 168–169

**E**

E6B 49–50  
edit  
    route 75, 76, 77  
    waypoints 78, 79  
elevation 119  
emergency  
    aviation 19  
    marine 168  
entering data 9, 10  
erase. *See* delete  
external power source 4

**F**

faster time 117  
FCC 168, 169, 180  
field 8  
find  
    from 58  
    from a different location 58, 59  
    menu 57, 60

    your current location 3  
finding an Item in automotive or  
    marine mode 58–60  
finding a nearby aviation point 18–22  
fishing information 112  
fish symbols 140  
flasher 142  
FlightBook 46, 170  
flight log 46  
flight plan 27  
    create 27  
    follow 28  
    locked 27  
following an automotive route 66  
following your flight plan 28  
follow roads 62  
FSS 18  
fuel flow 44, 47, 77

**G**

GARMIN DGPS 122  
getting satellite signals 4–6  
going to a destination 56  
go to 14, 15, 84  
    distress call 100  
    history 59  
    page 15, 23  
    point 92  
    position report 100  
GPS 163–164

    learning about 163  
    Off/On 5  
    page 6, 74  
GRI chain 166  
GSD 20A 135  
GTX 330 159  
guidance tab 118  
GXM 30 antenna 132  
    connecting 161

**H**

heading 120  
headphones 1  
highways  
    avoid 117  
Highway Page 114  
    automotive mode 70–71  
    data fields 71  
    page layout 71  
    setup 71  
HSI 40  
    bug indicator 34  
Hunt & Fish tab 112

**I**

icons 114  
identifier 6, 12, 14, 18, 168, 170  
information page 32, 60  
initialize 3, 163  
installation information 158–162

intersection 170

## J

Jeppesen database 27, 170  
updates 10

## K

keypad 7

## L

land at closest point 19  
language 116  
legs, track 90  
limited warranty 177  
line out 1  
lithium-ion 2  
lithium-ion battery 1  
local time 119  
location 6, 65  
location format 120, 167  
locked route 27  
log filter 113  
longitude 175  
LORAN TD setup 165–166  
lost satellite reception 5

## M

magnetic variation 120  
main menu  
    Display Tab 114  
    GPS tab 4

    Sound Tab 115  
managing routes 74  
managing tracks 87  
managing waypoints 78  
Man OverBoard 92  
map  
    information 36, 60  
MapSource 10, 160  
map data 36  
map datum 167  
map orientation 30  
Map Page  
    automotive mode 69  
    aviation mode 29–36  
    declutter 33  
    marine mode 93  
    setup 34  
marine timer 95  
maritime mobile service identity.  
    *See* MMSI  
marking a waypoint 26, 63, 64, 65, 81  
    underwater 139  
mark my location 26  
maximum speed 47  
MayDay 169  
measuring distance 33  
messages 113, 177–180  
military time 119  
Mils 119  
MMSI 96, 168, 169

MOB 92  
modes 55, 116  
moon information 109

## N

navigate  
    route 75  
    to point 92  
    track 90  
navigating  
    distress call 100  
    position report 100  
navigating in automotive mode 56–57  
navigating in marine mode 92  
navigation alarms 106  
NDB 18, 170  
near  
    current route 59, 60  
    destination 59, 60  
    next 59, 60  
    other 59, 60  
NEAREST/FIND key 18  
nearest type 45, 73  
new  
    altitude 6  
    location 6, 12  
    waypoint 65, 81  
next turn 106, 118  
NMEA 122, 124, 161  
north up 6, 30

no beacon signal 164

## O

OBS 41  
obstacle alert 28  
odometer 73  
off-route recalculation 118  
off course 107  
off road 117  
on-screen button 8  
options menu 9  
overzoom 30

## P

page layout 35  
page sequence 91  
panel page  
    aviation mode 40–43  
panning the map 29, 31  
pan mode 29, 31  
PC interface cable 160  
persistent alarm 106  
plan flight 44, 77  
plan route 44, 77  
points of interest 58  
Points tab 83  
pop-up alerts 28  
position 163  
position data page  
    aviation mode 45

position mode 29  
position report 168–169  
power 2, 3, 158  
    connector 1, 4  
practice mode. *See* simulator mode  
preferences  
    location 167  
pressure 119  
projecting a waypoint 81–86  
project location 81  
proximity 86  
    alarms 86  
    points tab 85  
    waypoint 86

## R

receiver not usable 5  
receiver status 5  
receive satellite signals 3  
record mode 87, 90  
reference position 59  
release hold 41  
reset timer 118  
reset trip 45, 73  
retrace your path 90  
review  
    route 75  
    waypoint 78  
road 70  
road routing tab 117

route 76, 90  
    add points 76  
    add waypoint to 80  
    edit 76, 77  
    editing 67–68  
    leg transition 74  
    options menu 74  
    preference 117  
routes 61–62, 163  
    automotive mode 74–77  
    editing 74–77  
    navigating a saved route 75–77  
route tab 74  
RTCM 122, 124  
runway criteria 22

## S

safety and product information 177–180  
sail boat racing timer 95  
satellite acquisition 5  
saved route 27, 74  
saved track 90  
save present location 63  
save track log 88  
saving the current route 72  
scanning for beacon 164  
scan for a frequency 123  
searching the sky 5  
search history 59  
selecting an approach 23–24  
selecting options 9  
sentences 125, 161  
serial communications port 159  
serial data format 121  
serial number 1  
setting up XM WX 127  
Setup tab  
    Guidance tab 118  
    Road Routing tab 117  
    System tab 116  
    Timers tab 118  
    Time tab 119  
    Units tab 119  
    Welcome tab 121  
set an alarm 106  
set CDI scale 41  
set date 119  
set OBS and Hold 41  
set speed and fuel 44, 77  
show details 15  
show map 79  
signal strength 5  
simulated navigation 11–12  
simulator  
    11  
smart airspace 32  
sonar 135, 136–139  
    adjusting 137–139  
    on the map page 135

    setting up 140, 142  
    understanding 143  
sonar alarms 108  
Sound tab 115  
specifications 155  
speed 40, 47  
speed filter 116  
split screen, sonar 139  
storage 156  
Sun & Moon tab 109  
switch modes 13, 55, 91  
system alarms 107  
System tab 116

## T

temperature 119, 146  
terrain  
    alert 28  
Terrain Page  
    aviation mode 37–39  
    declutter 33  
terrain warning 38  
text language 116  
thermoclines 145  
tide  
    chart 111  
    information 110  
    station 111  
    tab 110  
time



- delay 165
- format 119
- offsets 167
- tab 119
- zone 119
- timer 95
- Timers tab 118
- TIS 147, 152
  - limitations 148
  - operational procedures 153
  - symbology 150
- TIS traffic data 159
- track
  - legs 90
  - log 87, 88, 90
  - review page 88, 89
  - tab 87
  - TracBack 89, 90
- track up 6, 30
- traffic ground track 151
- traffic warning window 151
- transducer 140, 144
- trip computer 73
- trip planning 77
- true airspeed 50
- tuning beacon 164
- turn-by-turn route 56, 66, 75
- turn on and off 3
- U**
  - underwater waypoints 139
  - Units tab 119
  - unpaved roads 117
  - updates to jeppesen database 170
  - usage mode 13, 116
  - usage restrictions 16
  - USB 121
    - data cable 160
  - User Points tab 83
  - UTC 119
  - UTM/UPS 167
- V**
  - vectors 24
  - vertical navigation. *See* VNAV
  - vertical speed 119
  - VHF 168
  - VHF Comm 154
  - view details 31
  - VNAV 42, 43
    - indicator 42
    - profile 42
  - volume 3, 115
  - VOR 18, 170
- W**
  - WAAS 6, 116, 158, 163, 164
  - Warning Page 3
  - waterproof 156
  - water speed 141
  - water temp 108
  - waypoint 15, 26, 63–65, 163
    - categories 82, 83
    - create 26, 64, 81
    - edit 78, 79
    - Information Page 60
    - manage 78
    - mark 26
    - name 79
    - proximity 86
    - symbol 79
    - transition 74
  - weather information
    - finding 133
  - Weather tab 130
    - options menu 131
  - weight & balance 48
  - whiteline 138, 145
  - wide area augmentation system.
    - See* WAAS
  - winds aloft 50
  - Wx 18
- X**
  - xImage 160
  - XM Audio Page 51
    - favorites 53
    - mute 54
  - options 52
    - turning on 51
  - XM WX
    - additional information 132
    - options 127
    - radio ID 132
    - viewing 126
  - XM WX Weather
    - finding weather information 133
  - X symbol on terrain 37
- Z**
  - zoom 30

**For the latest free software updates (excluding map data) throughout the life of your  
Garmin products, visit the Garmin Web site at [www.garmin.com](http://www.garmin.com).**



© Copyright 2006–2007 Garmin Ltd. or its subsidiaries

Garmin International, Inc.  
1200 East 151st Street, Olathe, Kansas 66062, USA

Garmin (Europe) Ltd.  
Liberty House, Hounslow Business Park, Southampton, Hampshire, SO40 9RB UK

Garmin Corporation  
No. 68, Jangshu 2nd Road, Shijr, Taipei County, Taiwan

[www.garmin.com](http://www.garmin.com)

Part Number 190-00693-00 Rev. E